

Simple Television between Two Rooms

6^d
MONTHLY

Television

The Official Organ of the Television Society

VOL 1. MAY 1928 No. 3

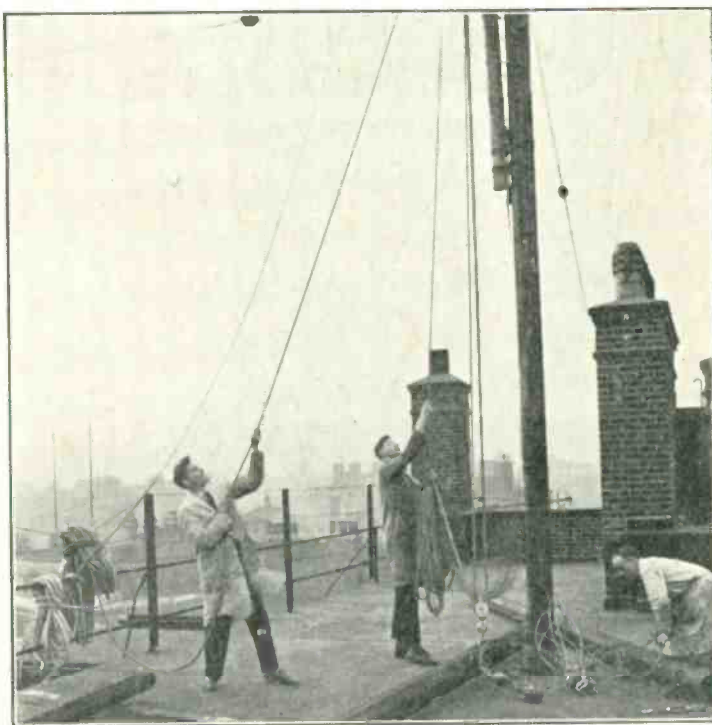

SIGNS OF THE TIMES

One of the 72 foot wireless masts being erected on the roof of the Baird Television Development Co.'s new offices and laboratories in Long Acre. On the left can be seen faintly the two old masts formerly used by Mr. Baird during his original experiments in the wireless transmission of Television



THE WORLDS FIRST TELEVISION JOURNAL

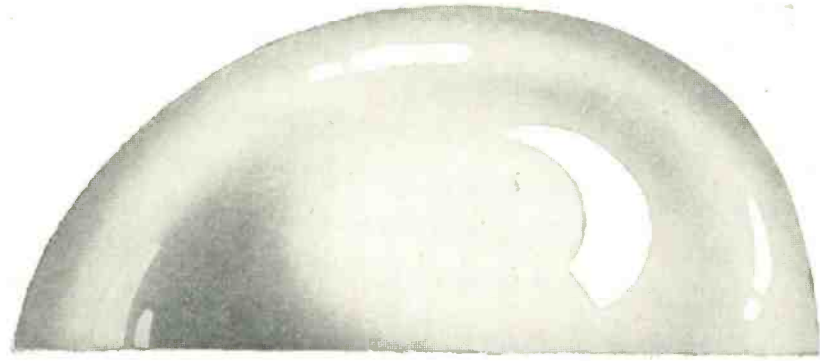

Mullard

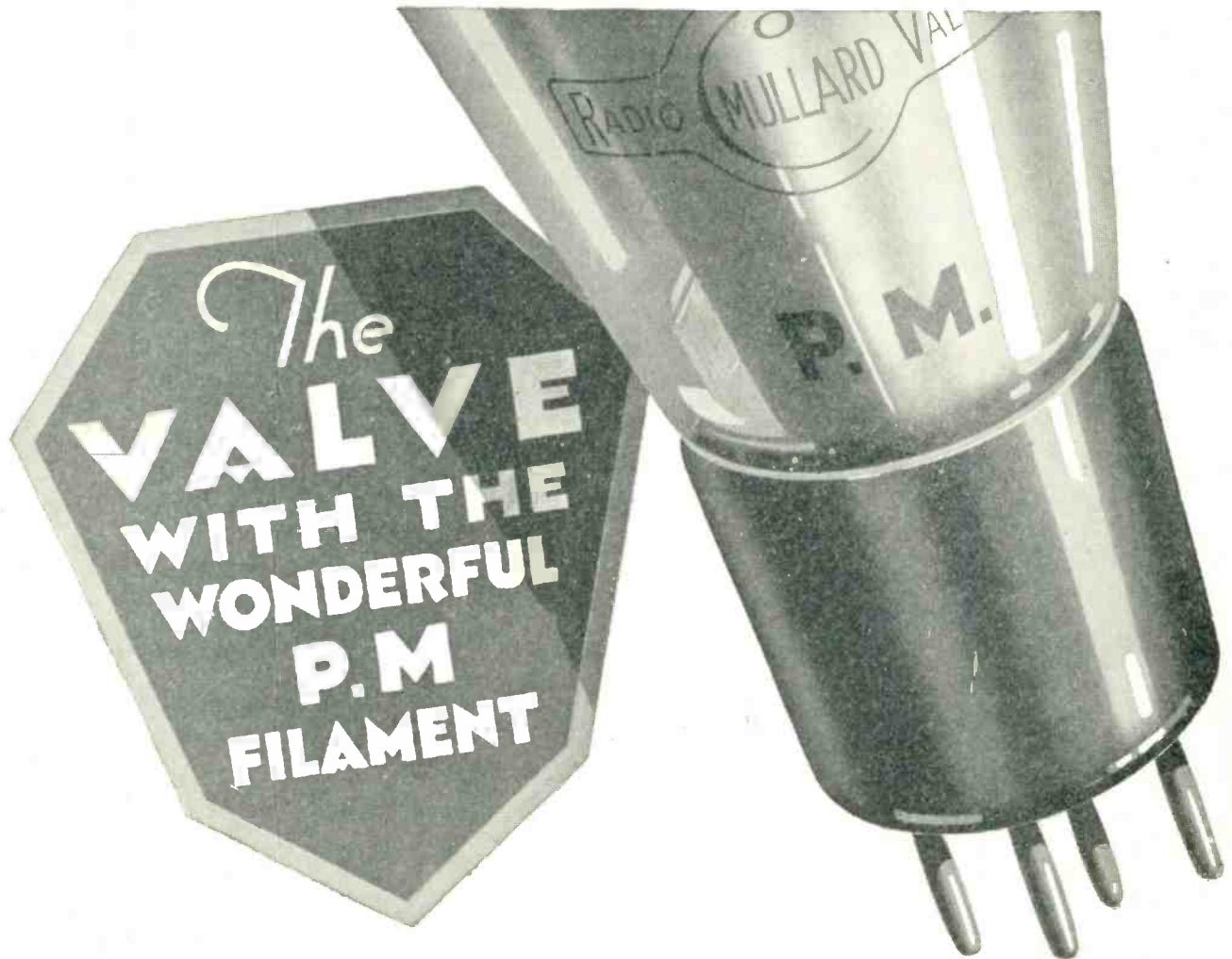

THE · MASTER · VALVE

YOU CAN BANISH BATTERY TROUBLES—FOREVER.



HIGH TENSION AT EVEN TENSION

HOW 'CONSTANT POWER PRESSURE' MAKES AMAZING IMPROVEMENT IN RECEPTION.

Ask any Standard Wet H.T. Battery user. He will tell you the purity of tone and complete absence of background noise is astonishing. Yet the explanation is simple. The flow of current from this highly efficient battery is absolutely steady, smooth and uniform. Hours of daily service for months on end does not show any violent variation in voltage. The secret is—it recharges itself overnight.

IMPORTANT. Experimenters contemplating building a Televisor must employ an UN-VARYING H.T. current to get good results. The Standard Battery is specially suitable for this reason and can be built up to any required voltage.

Get YOUR Copy of this FREE BOOK

Take the first step by sending for FREE booklet describing every detail for installing and maintaining this super-efficient and money-saving battery.

(Dept. T.) THE WET H.T. BATTERY CO.
12, 13 & 14, Brownlow Street, London, W.C.1

STANDARD



The Vital Power in Radio!

Woolworth's Stores are now distributing No. 2 cell completely assembled at 6d. each. Also "Standard" Electrolyte chemical in 6d. bottles. All types of the battery are also obtainable from Halford's Cycle Stores and Wireless Dealers.

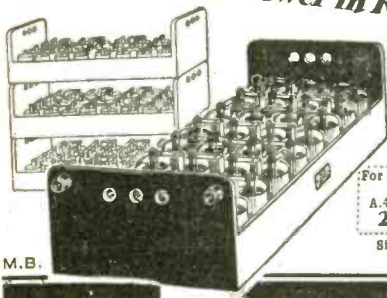

THE "UNIBLOC" CABINETS

New design. Halves space. Saves room. Price with 32 No. 1 Cells, 48 Volts . . . 18/-

For 2-VALVE SETS . . .	3-5-VALVE SETS . . .	SUPER SETS . . .
A. 4. 80 volts	D. 8. 108 volts	F. 6. 128 volts
24/10	38/6	69/3

Single units of 1½ volts from 4jd. each. Carriage Paid on Cash Orders.

M.B.

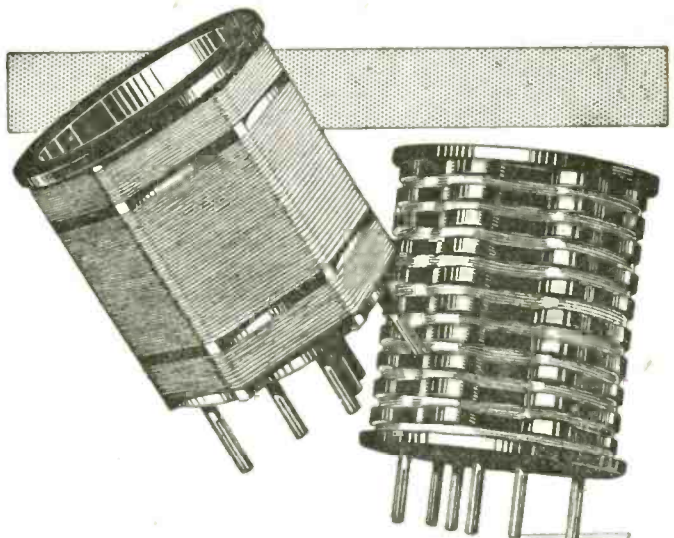

ULTRA-SHORT WAVE COILS ARE NOW AVAILABLE FOR THIS RECEIVER



If you are about to construct the Mullard Master Three Receiver you should remember that there is every reason why you should adhere to the author's specification.

SELECTIVITY to the highest degree is easily obtained with Colvern Coils. A few turns to requirement should be removed from the aerial winding and the end of the wire reconnected to Pin No. 4.

RANGE depends to an extremely high degree upon efficient coils, and it is very important that these should have a very low high-frequency resistance. To obtain this Colvern Coils are accurate space-wound. Experience proves that the use of Colvern Coils increases the range of a radio receiver. In the case of the Master Three Colvern Coils give maximum range on each of the three wavebands.

VOLUME is similarly dependent upon the efficiency of coils. Logically, the signal-strength of distant stations is greatly increased by Colvern Accurate Space-Wound Coils.

Therefore be advised—adhere strictly to the author's specification, you will be most satisfied.

Prices:—

Two Short Wave Coils: Space-wound—20 to 45 metres, and 45 to 90 metres. **7/6** Each.

Broadcast Wave. Accurate Space-wound to give maximum efficiency. **7/6** Each.

Long Wave. Sectional wound to give lowest high-frequency resistance. **8/6** Each.

Colvern Aluminium Panel. **7/6** Each.

is also specified for the Mullard Master Three Receiver 18" x 7" : 14 gauge; sprayed instrument black; drilled for variable condensers; switch and panel brackets.

COLVERN ACCURATE SPACE WOUND COILS

Colvern Ltd., Mawney's Road, Romford.

Mention of "Television" when replying to advertisements will ensure prompt attention.

E.E.C Motors FOR TELEVISION

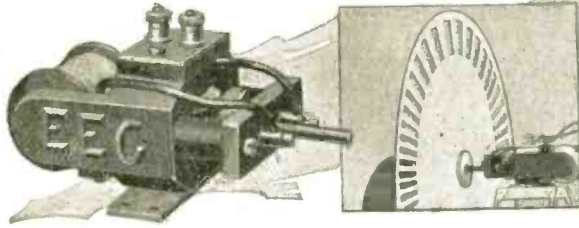

6-Volt Motor
21/-

Standardised by most Manufacturers of Television Apparatus.

These Special Motors are made by

ECONOMIC ELECTRIC, LTD.

FIRST MANUFACTURERS
(1908)

OF RADIO APPARATUS FOR AMATEURS
in Great Britain.

ECONOMIC ELECTRIC, LTD.,
10, Fitzroy Square, LONDON, N.W.1.

THE UNIQUE

VARIABLE FRICTION BRAKE

What the Experts say!

"... the moving vanes of the J.B. variables ... can be tightened by means of the ingenious friction devices incorporated in their movements. There is a small round-headed screw on each which takes up the pressure applied to the spindles by a small collar."

POPULAR WIRELESS.
Both S.L.F. and Log. Plain models are equipped with this unique Variable Friction Brake.

Prices of J.B., S.L.F. and Log. Plain Models.
-0005 mfd., 11/6 ; -00035 mfd., 10/6 ;
-00025 mfd., 10/-
-00015 mfd. (S.L.F.), 10/-
-0001 mfd. (Log.), 10/-

JACKSON BROS
8 POLAND ST. OXFORD ST.
LONDON - W.1 Telephone GERARD 7400



THE SOVEREIGN SHORT WAVE (18 to 90 metres) SIX-PIN COILS

for the
MULLARD MASTER THREE
and
MIKADO P.M. RECEIVERS

5/-

are now available at your
dealers.

J. R. WIRELESS CO.

6-8 Rosebery Avenue, Clerkenwell, London, E.C.1
Telephone : Clerkenwell 9515.

Sectional wound, covers wave-
band 15 to 4,000 metres, in-
ductance 175,000 m.H., self-
capacity 5 m.mfd. Price 5/-

CDM COMPONENTS

FIXED CONDENSERS.

- 00005 to ·002 - - @ 1/8
- 0025 to ·006 - - @ 2/-
- 0003 with meg. leak @ 2/-
- 01 - - - - @ 3/6

H.F. CHOKES 5/- & 4/-
Suitable for Long and
Short Waves,
15 to 2,000 Metres.

**ALWAYS INSIST ON
CDM GOODS.**

YOUR SET HAS NOT GIVEN BEST RESULTS IF
YOU HAVE NOT INCORPORATED
THE WORLD-FAMOUS CDM COMPONENTS.



Patent No. 275800

Manufactured solely by **C. D. MELHUSH**, 8, Great Sutton Street,
Goswell Rd., London, E.C.1
Telephone : CLERKENWELL 7494.

To Constructors of Television Sets!

It is significant that "Hart" Batteries are used in the pioneer experimental work of Mr. J. L. Baird.

HART BATTERIES

FOR ALL WIRELESS CIRCUITS

You will find "HART" High Tension Batteries essential to secure the best results with Television Apparatus.
Fill in the attached coupon and we will send you full particulars.

HART ACCUMULATOR CO., Ltd.
STRATFORD, LONDON, E.15.

Dear Sirs,—I am interested in "Television" and shall be glad to receive particulars of suitable "HART" Batteries for use with same.

Name _____
Address _____

Mention of "Television" when replying to advertisements will ensure prompt attention.

Take up Television

BE one of the first television experimenters in your district! This new field offers unlimited scope for experimental developments that directly result from the efforts and brains of keen amateurs. You have every opportunity for success and your requirements can be fully met by the one firm established to specialise in television apparatus. Television Supplies Ltd. are directly in touch with the most reliable information, designs and apparatus for television experimenters.

All the essential components for the Simple Televisor are available correct to specification. Distribution will be made through your radio dealer.

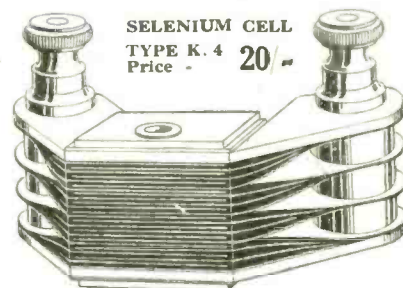

SELENIUM CELL
TYPE K.4 20/-
Price -

Selenium Cells The heart of Television

THERE is no doubt that the whole success of the Simple Televisor described in this magazine lies in the use of a high efficiency ultra-sensitive Selenium Cell. Television Supplies Limited have concentrated on the design of the most efficient Selenium Cell yet invented. Its chief characteristics are:—(1) Unequalled Sensitivity. (2) Lowest Resistance. (3) Highest Ratio. (4) Negligible Lag. (5) Reliability, Constancy and Robustness. (6) Every Cell gives practically instantaneous response to rapid variations in light intensity and is subjected to searching tests for sensitivity before despatch.

SELENIUM CELL Type K.4, condenser pattern, has a sensitised area of approximately 400 square mm. This Cell is of the highest sensitivity, lowest resistance, and greatest robustness of any Selenium Cell yet designed.

SELENIUM CELL Type G.1, grid pattern, is a cheaper but quite satisfactory type of cell capable of excellent performance. Both these Cells are eminently suitable for the experimental Televisor described in this magazine.

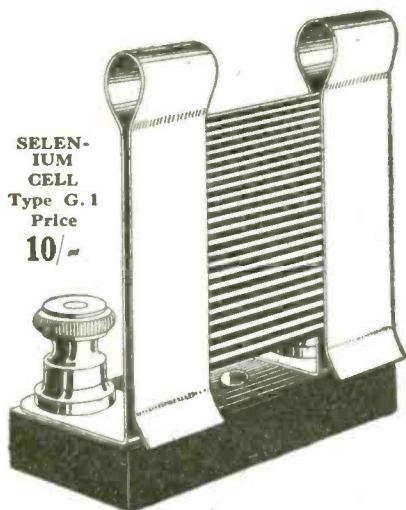

SELENIUM CELL
Type G.1
Price
10/-

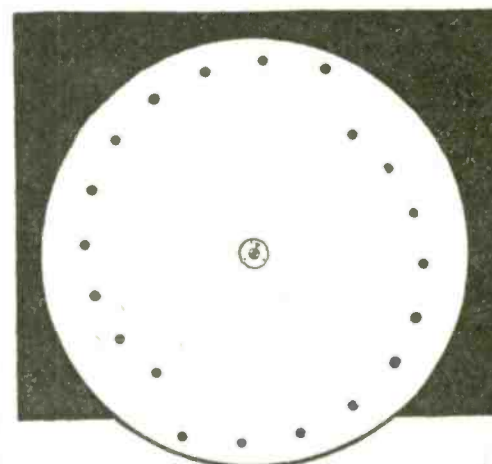

Spiral Disc as specified, 20 in. diam. aluminium.

Everything for Television

SLOTTED DISC Type D.50, specially designed for use as the interruptor disc. Accurately cut to specification from aluminium and fitted with brass bush and locking screw. 14 in. diam. 7/6

SPIRAL DISC Type D.20, accurately cut to specification from heavy gauge aluminium and fitted with brass bush and locking screw. 20 in. diam. 15/-

ELECTRIC MOTOR Type E.2, A well made electric motor for either slotted disc or spiral disc 21/-

CONTROL RHEOSTAT Type C.N.201, Climax Metal Cooled rheostat, 6 ohm pattern 3/-

FOCUSING MIRROR Type M.10, Magin type, of the best quality, 10 cms. diameter 7/6

RECEPTION SCREEN. A Gelatine screen with ground surface for seeing the transmitted image 1/-

Complete Amplifiers and Component Parts for Television Circuits on application.

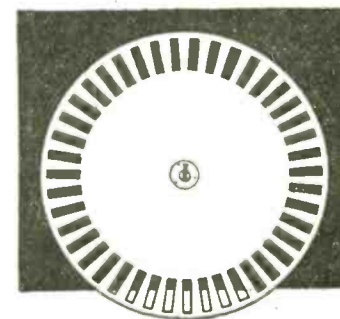

Slotted Disc as specified, 14 in diam. aluminium.

Television

SUPPLIES LTD.

Quill Lane, Putney, London, S.W.15

Mention of "Television" when replying to advertisements will ensure prompt attention.

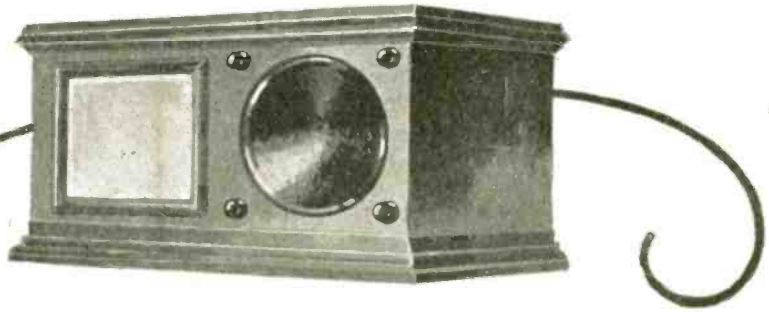

WIRELESS



ELECTRICITY

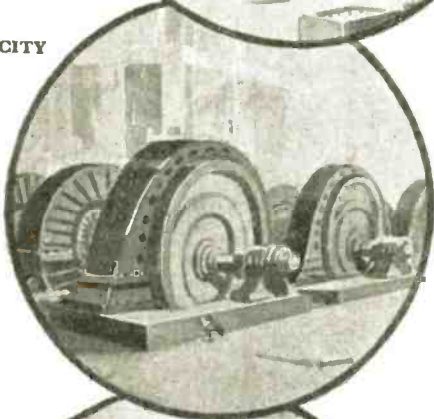

MECHANICS



OPTICS



CHEMISTRY

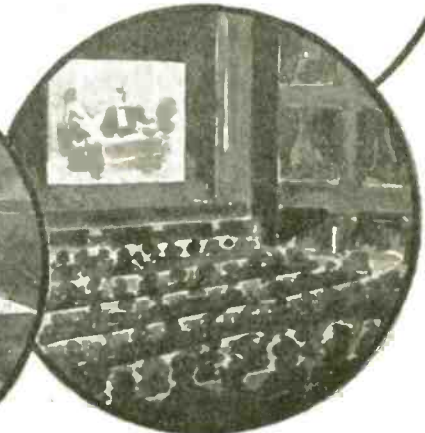

CINEMATOGRAPHY

MAY 1928

	PAGE
EDITORIAL	7
WHAT IS WRONG WITH BROADCASTING ?	8
PHOTO ELECTRIC CELLS	9
<i>By Dr. J. A. Fleming, F.R.S.</i>	
FROM INVENTION TO COMMERCIALISATION: PITFALLS TO AVOID	12
<i>By "Alpha."</i>	
THE VILLAGER LOOKS AROUND	15
<i>By Charles Jones.</i>	
THE POWER OF OPTICAL INSTRUMENTS	16
<i>By Professor Cheshire, C.B.E., A.R.C.S., F.I.P.</i>	
SELENIUM: ITS CHEMICAL AND MICROSCOPICAL CHARACTERISTICS	18
<i>By James Scott, F.R.S.A.</i>	
VISIBLE SPEECH ACROSS THE ATLANTIC	20
<i>By Lt.-Col. Chetwode Crawley, M.I.E.E.</i> <i>(Deputy Inspector of Wireless Telegraphy, G.P.O.)</i>	
SIMPLE TELEVISION BETWEEN TWO ROOMS	22
<i>By our Technical Staff.</i>	
METHODS OF SYNCHRONISM IN TELEVISION	26
<i>By the Editor.</i>	
THE PROTECTION OF TELEVISION INVENTIONS	30
<i>By Patent Expert.</i>	
JOCK MCKAY, TELEVISIONARY	32
<i>By Richard Carol.</i>	
ONE OR TWO MORE POINTS ON THE TELEVISION AMPLIFIER	33
<i>By James B. Elmore.</i>	
TELEVISION PROBLEMS AND THEIR SOLUTION	34
<i>By C. B. Maxwell.</i>	
THE TELEVISION SOCIETY: REPORT ON FIRST FORMAL MEETING	37
NATURAL VISION AND TELEVISION: PART I.—THE RUDIMENTS OF SIGHT AND COLOUR VISION	40
<i>By J. Darbyshire Monteath.</i>	
THE BEST LETTERS OF THE MONTH	43



Varley
LTD.

AND
TELEVISION



Straight Line Super Transformer.

Ratio 3.5 to 1.

25/-

Terminals:

3 and 6 Primary.
4 and 5 Secondary.

AT the NATIONAL RADIO EXHIBITION, Olympia, held in September, 1927, we had on show eighteen new products. The previous six months was a record of ruthless scrapping of any existing products that were not up-to-date, and the designing of new and better components incorporating the most modern developments of radio science.

The R.I. and Varley Straight Line Super Transformer is one of the most popular radio components of to-day. The National Physical Laboratory Curve of this famous Transformer shows its amplification to be practically constant from 100 to 6,000 cycles, with exceptionally good results even as low as 20 cycles. It can be used with success in any transformer-coupled receiver, in fact its universal application is on a par with its remarkable efficiency.

Our Bi-duplex wire-wound Resistances have built up a reputation for efficiency in almost every corner of the globe—they are the last word in reliability and perfection of design. Write for particulars of our Tapped and Variable Resistances, also of our new Super Power Resistances which have been designed to carry a current up to 50 milliamperes.



Bi-duplex Wire-wound Anode Resistances.

Made in a complete range of sizes up to 500,000 ohms. Prices complete with universal holder, 5/6 to 17/6.



THE MARK OF PROGRESS

Kingsway House, 103 Kingsway, London, W.C.2.

Telephone: Holborn 5303.

Mention of "Television" when replying to advertisements will ensure prompt attention.

TELEVISION

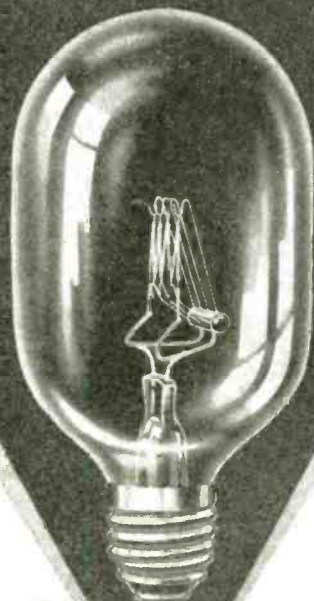

Philips Projector Lamps are suitable for use in the simple Transmitter described in this issue. Philips Neon Lamps can also be supplied for this apparatus.

Use Philips Lamps—and See
Makers of all types of Electric Lamps

PHILIPS PROJECTOR LAMPS

PHILIPS LAMPS LTD., PHILIPS HOUSE, 145, CHARING CROSS ROAD, LONDON, W.C.2
Mention of "Television" when replying to advertisements will ensure prompt attention.

Television



THE WORLD'S FIRST TELEVISION JOURNAL

The Official Organ of The Television Society

Edited by A. DINSDALE, A.M.I.R.E.

Consultants: Dr. C. TIERNEY, D.Sc., F.R.M.S.; W. J. JARRARD, B.Sc. (1st Hons. Lond.), A.R.C.S., A.I.C.

Technical Editor: J. C. RENNIE, B.Sc., A.M.I.E.E.

Vol. I]

MAY 1928

[No. 3

EDITORIAL

IT is a source of considerable gratification to us to be able to present to our readers this month a most informative article on the subject of photo-electric cells, by no less an authority than Dr. J. A. Fleming, F.R.S.

DR. FLEMING requires no introduction to our readers, for his name is already a household word in connection with the thermionic valve, of which he is the inventor. This wonderful invention revolutionised wireless communication in its early days, and made possible wireless telegraphy, telephony, and broadcasting, as we know them to-day. Without the aid of this marvellous Aladdin's lamp, television would not be an achieved fact to-day.

IN addition to being a scientist and inventor of world-wide distinction, Dr. Fleming is the author of a large number of scientific papers of inestimable value, and the author also of many textbooks. His "Principles of Electric

Wave Telegraphy and Telephony," published in 1906, was for long the only standard textbook on the subject available in this country.

* * *

JUDGING from the large number of letters which continue to reach us from readers, our constructional articles on the Simple Televisor have created a very widespread interest, and many amateurs throughout the country

Editorial & Publishing Offices:

The Television Press,
Limited,

26, Charing Cross Road,
London, W.C.2.

Telephone: Regent 6437.

SUBSCRIPTION RATES, 7/6 PER ANNUM,
POST FREE.

MSS. and other material for Editorial consideration should be accompanied by a stamped addressed envelope, and should be typewritten.

are busily engaged in performing experiments.

THIS month we have gone a step farther, and given full constructional details of apparatus which will enable readers to conduct simple television experiments between two entirely separate machines. In accordance with our policy, we have endeavoured to minimise the expense involved, as far as possible, by slightly modifying the Simple Televisor described in our last two issues, so that it now acts as a transmitter only.

THIS new departure brings us immediately face to face with one of the outstanding difficulties of television, that of synchronism, and we have devoted a considerable amount of space to the subject in order to give our readers a clear insight into its mysteries.

* * *

NEXT month we hope to be in a position to describe further methods and apparatus now being developed by our technical staff.

Entire contents of this Journal copyright in the U.S.A., 1928, by Television Press, Ltd.

Foreign Translation Rights reserved.

What is wrong with Broadcasting . . . ?



WITH APOLOGIES TO THE B.B.C.



Photo Electric Cells

By
Dr J. A. Fleming F.R.S.

THE accomplishment of television and also of the transmission of "still" pictures by wire or by radio-waves is essentially dependent upon the possession of means by which the variation in intensity or brightness of a ray of light may be made to vary the strength of an electric current in exactly the same proportion.

Two methods, so far, have been found. In one of these the resistance of an electrical conductor is altered by a ray of light impinging on it, so that when it forms part of a circuit in which there is an external impressed electromotive force (E.M.F.) the current changes nearly proportionately to the intensity of the light. Such a material is selenium in certain states, and a few other substances.

Photo-Electric Substances.

The second method involves the use of a material which creates an electric current or electromotive force when light of a certain kind falls upon it. These latter substances are called photo-electrics. We shall not, in this article, concern ourselves with the first class of appliances, viz. the resistance-varying materials, but solely with the latter, as for reasons to be explained the photo-electric appliances have great advantages for the above-named purposes.

The starting-point for this invention was a discovery made by Hallwachs in 1888 that plates of certain metals, when illuminated by ultra-violet light from an electric arc or spark, rapidly lose a charge of negative electricity given to them. Also, it was found that such an insulated plate, if uncharged, rapidly acquires a positive charge when ultra-violet light falls upon it. The methods of studying it were de-

veloped by Hoor, Righi, and Stolew. The student can easily repeat these experiments, as follows:

Construct an insulating stand consisting of a rod of ebonite stuck into a base of paraffined wood (see Fig. 1). Fix on the top of the rod a brass clip to hold small plates of metal about four inches square.

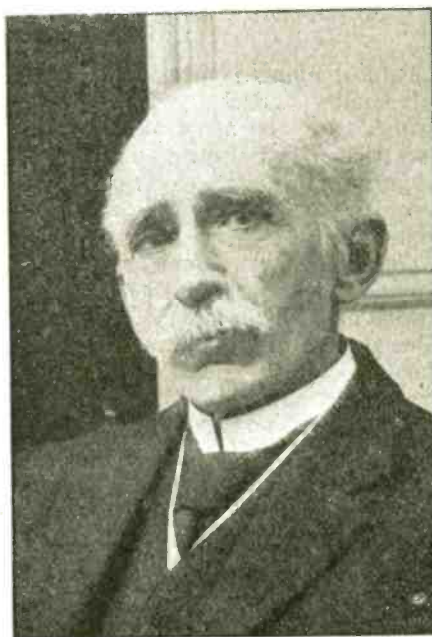

Dr. J. A. Fleming, F.R.S., who says:

"There is no doubt much room for improvement in the construction of these 'artificial eyes,' but before long they will be sold in the wireless shops just like telephones or microphones are now sold, and amateurs will build up their own television receiving sets."

Prepare a similar stand to hold a small square of coarse metal gauze. The stands must be such that the metal plate and the gauze can be held parallel to each other and about a quarter of an inch apart, but not touching.

Next provide a gold leaf electro-scope, which can be connected by a

wire to the clip holding the metal plate. Also provide small plates, about four or six inches square, of zinc, aluminium, copper and sheet-tin. Connect the gauze with the earth by wire. Then perform the following experiments, which can easily be shown as lecture experiments by projecting the shadow of the gold leaf electro-scope upon a screen.

A Polished Surface Essential.

Polish one side of each metal plate very carefully by rubbing it with fine glass-paper. Place first the zinc plate in its clip with the polished side facing the gauze plate. Then give the zinc plate a small charge of negative electricity, so as to cause a good divergence of the gold leaves of the electro-scope and let it stand for a minute or two to see if the insulation is good enough. Then, if it is, burn an inch or two of magnesium ribbon in front of the gauze plate, but a foot or two away. This will produce a powerful ultra-violet or actinic light, which will fall upon the polished plate.

It will be found that the electro-scope leaves rapidly collapse, thus showing that a polished zinc plate loses a negative charge under the influence of this light.

Results with other Metals.

Next try giving the zinc plate a positive charge and repeat the experiment. It will be found that the light does not discharge positive electricity.

If we try the same experiments with the polished aluminium plate it will be found to be nearly as good as the zinc, but the copper or tin plate will hardly show the effect at all. This loss of negative charge under the influence of light is called the photo-electric effect. The metals

which show it best are the highly electropositive ones, or those which are easily oxidized.

An effect which soon presents itself is that called "photo-electric fatigue." If the experiment with the zinc plate is repeated several times without repolishing the plate, it will be found to become less and less vigorous, but it can be restored to its original vigour by well repolishing the plate. The gradual deterioration is due to oxidation or to the adherence of gas films.

Measurement of Effect by Galvo Deflection.

Another way in which the effect can be shown is with a sensitive high resistance galvanometer. Connect the negative terminal of a high tension battery of 100 or 200 volts, such as is used in wireless receivers, with the metal plate, and connect the positive end with the gauze through the galvanometer (see Fig. 2). Then it will be found that the galvo indicates no current until the plate is illuminated by ultra-violet light from an arc lamp or from burning magnesium, or from a quartz tube mercury arc lamp. The galvo then shows a deflection which increases with the intensity of the illumination on the zinc plate. In this way we can see the manner in which an electric current can be created proportional to the intensity of a certain beam of light.

The scientific exploration of these phenomena, as revealed by the researches of Sir J. J. Thomson and many others, showed that the photo-

electric effect was due to the liberation of electrons from the atoms of the active metal. The present-day theory of atomic structure is that

When a ray of light of a certain frequency n falls on an atom it may detach these valency electrons. To do this a certain amount of work,

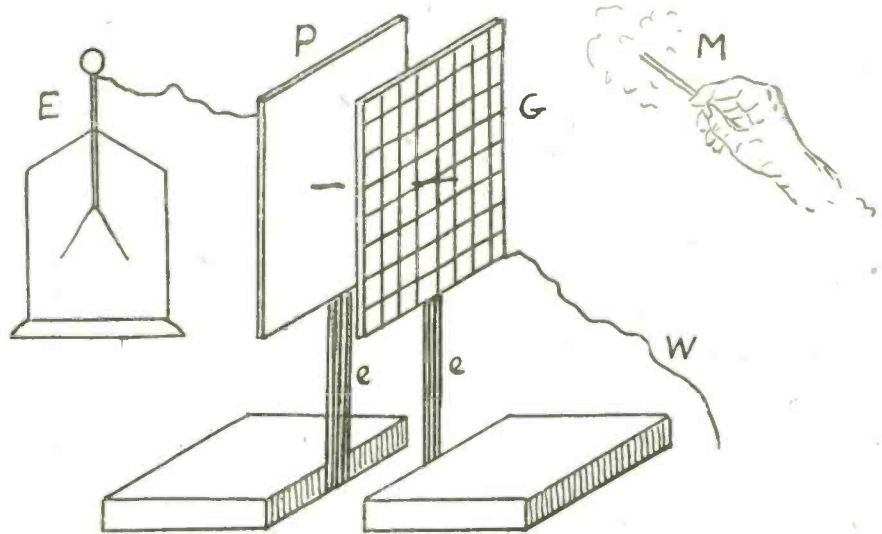

Fig. 1. An experiment illustrating the photo-electric effect. P, zinc or magnesium plate; G, wire grid; E, electroscope; W, earth wire; M, magnesium wire burnt to produce ultra-violet; ee, ebonite pillars.

chemical atoms comprise two kinds of smaller particles called protons, which are elements of positive electricity, and electrons, which are elements of negative electricity. The protons and some electrons are united into a very compact mass called the nucleus, and around this circulate the rest of the electrons, which are called planetary electrons. One or two of the outermost planetary electrons are more easily detached than the others and are called the valency or photo-electrons.

w , reckoned in ergs, has to be done, and the electron is then shot off from the surface with a velocity v , and a kinetic energy $\frac{1}{2}mv^2$, where m is the mass of the electron. This mass is nearly equal to $9 \div 10^{28}$ of a gram. Einstein showed that in photo-electric phenomena there is a relation between n , w , and $\frac{1}{2}mv^2$, expressed by the equation $\frac{1}{2}mv^2 + w = nh$, where h is a constant of Nature called Planck's constant, and it is equal to $6.55 \div 10^{27}$.

Calculation of Minimum Light Frequency required to cause Emission.

Accordingly, in order that the electron may be shot off at all we must have nh greater than w .

In others words: If the frequency of the incident light is less than a certain amount, depending upon the metal, no photo-electrons are driven off by it from that metal, no matter how long the illumination lasts, nor how intense it may be. It is always the custom to reckon w as the product of a certain number of volts and the electron charge e in electromagnetic units where $e = 1.6 \div 10^{20}$ C.G.S. units. This voltage is called the ionizing voltage. For magnesium it is about 3 volts and for zinc about 3.77.

We can then calculate what is the lowest frequency of light which

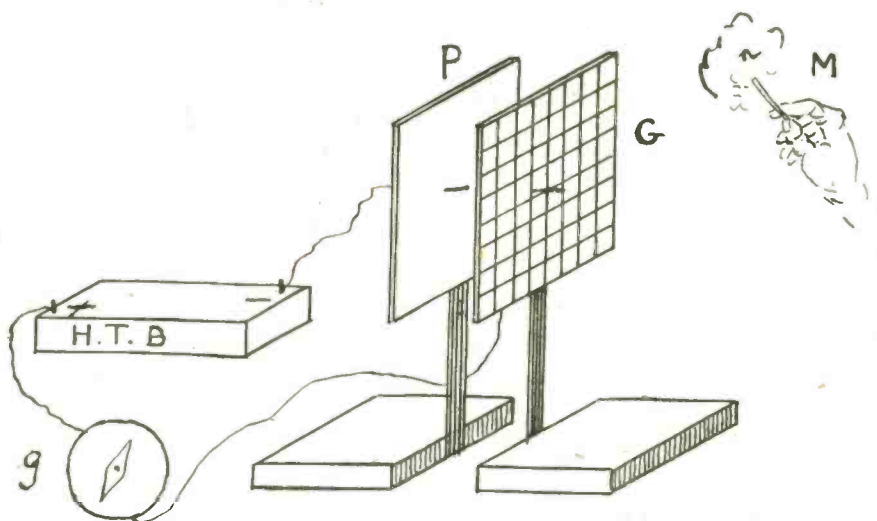

Fig. 2. Another arrangement of apparatus for demonstrating photo-electricity. P, zinc or magnesium plate; G, wire grid; g, galvanometer; M, magnesium wire burnt; HTB, high tension battery, 200 volts.

will just cause photo-electric emission from magnesium, as follows:—

$$V=3 \text{ volts} = 3 \times 10^8 \text{ C.G.S. units.}$$

$$e = \text{electronic charge} = 1.6 \times 10^{-20}$$

$$eV = \frac{1.6 \times 3 \times 10^8}{10^{20}} = \frac{48}{10^{13}} \text{ and } h = \frac{6.5}{10^{27}}$$

therefore

$$n = \frac{48}{10^{13}} \times \frac{10^{27}}{6.5} = \frac{48}{65} \times 10^{15} = 750 \times 10^{12}$$

This is the frequency of blue light just at the extreme end of the visible spectrum.

We can calculate in the same way the minimum frequency (n) for various metals, and we find it to be:

Metal.	n .	λ (Angstrom units).
Sodium ..	515×10^{12}	5800 yellow light
Aluminium	630×10^{12}	4800 blue light
Magnesium	785×10^{12}	3800 violet light
Zinc ..	800×10^{12}	3750
Tin ..	910×10^{12}	3300
Copper ..	1000×10^{12}	3300
Platinum ..	1040×10^{12}	2900

The figures under the column λ are the corresponding wave-lengths in Angstrom units (A.U.)—

$$(1 \text{ A.U.} = 10^{-8} \text{ cm.})$$

These figures show us that to produce photo-electric emission in the last four metals we require ultra-violet light, but that for sodium and the other alkali metals visible light in the middle of the spectrum will effect it. The exactness of Einstein's equation $\frac{1}{2}mv^2 + w = nh$ has been verified by R. A. Millikan and many other workers at the subject.

Metals belonging to the Alkali Group are best.

The upshot of all this investigation has been to show that for the purposes of practical television we must employ a photo-electric material of very small ionizing voltage, that is, one of the metals of the alkali series, viz. potassium, sodium, or rubidium.

But now there are various compounds which are even more photo-electric than pure metals. For instance, some of the sulphides of metals are highly photo-electric. The author of this paper discovered, some years ago, that in the case of rectifying couples used as crystal detectors in wireless telegraphic reception one of the two materials must be highly photo-electric.

Thus, for instance, a good rec-

tifying contact used in so-called crystal detectors is a crystal of galena or sulphide of lead, which is lightly touched by a gold or copper wire called a cat's whisker. Galena is very photo-electric

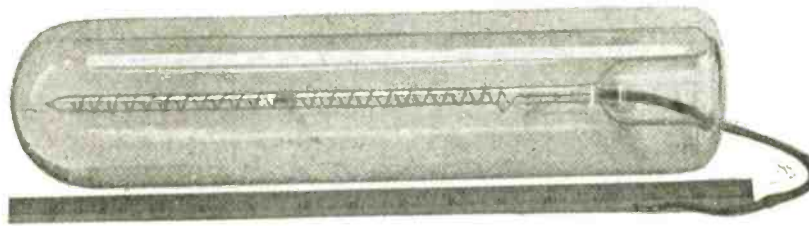

Fig. 3. One of the extra large photo-electric cells developed by the American Telephone and Telegraph Company. This cell presents 40 square inches of light-sensitive surface to receive light reflected from a subject being televised.

in its crystalline condition. In the same way another good detector is chalcopyrite or double sulphide of copper and iron touched by a crystal of zincite or zinc oxide. But chalcopyrite is photo-electric, whilst zincite, gold and copper are not so. A certain sulphide of thallium is said to be extremely photo-electric.

In the same manner it has been found that the hydrides or compounds with hydrogen of the alkali metals, potassium, sodium, etc., are very highly photo-electric and lose electrons copiously under the action of visible light. These materials, being very easily oxidized, have to be prepared in a high vacuum.

The construction of a modern photo-electric cell for television purposes is one involving great technical difficulties, but it is somewhat as follows:

A tube has to be prepared of suitable glass such as Uviol, which is

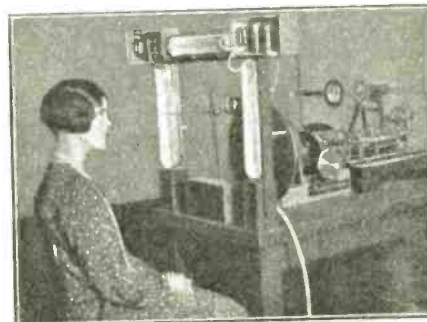

Fig. 4. A view of the television transmitting apparatus used by the American Telephone and Telegraph Company. Light from the arc lamp visible on the extreme right is condensed on the disc, which is driven by a high frequency synchronous motor. The disc carries a spiral of pin-hole apertures, each of which in turn projects a moving spot of light on the subject, as described by our Technical Editor in our last two issues. Light reflected from the subject is collected by the three large photo-electric cells.

fairly transparent to ultra-violet light. In this tube are placed fragments of clean potassium, the tube being kept full of inert gas or of hydrogen. By means of properly applied heat the potassium is melted, vaporized and caused to distil over and condense on a cool part of the tube or on some metal plate inserted in it to receive the potassium.

Within the tube is also sealed a metal anode which can be positively electrified to a voltage of 300 volts or so. The neutral gas in the tube is then replaced by dry hydrogen at a pressure of 2 or 3 mm. of mercury and a film of hydride is formed on the surface of the deposited metal by passing a glow discharge through the tube. The cell then becomes 100 times more sensitive to light than before. The cell is said to be more permanent if the hydrogen atmosphere is then replaced by helium or argon, and the glass tube sealed off. The anode should be about half a centimetre from the active surface.

Commercial Types of Cell.

The general appearance of the finished cell is shown in Fig. 3. Such a photo-electric cell is highly sensitive to light of about the middle violet part of the visible spectrum, and according to the calculations of Dr. H. S. Allen could detect the light of a candle at a distance of 2.7 miles.

If then feeble light falls on the photo-sensitive part of such a tube, the anode being positively electrified, an electric current flows through the tube and external circuit due to escape of electrons from the active surface.

This current is proportional to the intensity of the light falling on the tube. It can be amplified by thermionic valves, just as the feeble currents induced in a wireless receiving aerial are magnified to work a loud speaker telephone, and these currents can be sent along a telegraph line or used to actuate relay valves to operate a radio transmitter.

An even more sensitive form of photo-electric cell can be made with colloidal potassium which is in the form of a collection of small globules. A type of photo-electric cell made

by the General Electric Company resembles an artificial eye. It comprises a spherical bulb of glass with a portion of it formed of quartz glass, because this is very transparent to ultra-violet light not exceeding a certain wave-length. This window corresponds to the "pupil" of the eye. The retina of this artificial eye is the layer of hydride of potassium spread over the inside of the bulb, or it may be sodium or rubidium, which last is sensitive even to red light. This artificial eye generates an electric current when light enters it through the quartz window. A 60 c.p. lamp placed six inches from the window, according to Mr. T. Thorne Baker, will create a current of one hundred thousandth of a milliampere. This is a very small current, but we can increase it by using a number of such cells in parallel and conjoining these with a multiple valve thermionic amplifier.

Photo-Electric Cells give Instantaneous Response necessary for Television.

The great value of such photo-electric cells, as compared with selenium, is the instantaneous response of the photo-electric cell to variations in light intensity.

This is essential for the purposes of television.

One way in which such cells are used for television is as follows: The picture or living subject whose image is to be transmitted is "scanned" by a rapidly moving but very slender beam of light. This beam comes from a powerful arc lamp condensed by lenses and is transmitted through the spirally-arranged apertures in a rapidly revolving disc, so that a small beam of light traverses the subject in varying straight lines, so as to cover the whole of the subject, say a human face, in the one-seventh part of a second or less. Each little illuminated part of the subject then reflects scattered light and part of this falls on a set of photo-electric cells screened from direct light (see Fig. 4).

There is no doubt much room for improvement in the construction of these "artificial eyes," but before long they will be sold in the wireless shops just like telephones or microphones are now sold, and amateurs will build up their own television receiving sets.

From Invention to Commercialisation

Pitfalls to Avoid

By "Alpha"

"ALL inventors should be strangled at birth; and any that escape should be shot at sight!" Such was the outburst of an irate financier who had lost a considerable sum of money through financing wild-cat inventions.

"Financiers are nothing more nor less than despicable parasites, who unscrupulously exploit any luckless inventor who falls within their clutches." This from an inventor who had been robbed of the products of his brains and the fruits of his labours by a dishonest syndicate.

The marketing of an invention is one of the most difficult and dangerous problems with which the inventor is faced. Edison has stated that eighty per cent. of the work involved in making a success of an invention lay in the commercialisation of it; and this statement is well worthy of the notice of those who are in possession of some idea which they consider valuable.

The step from an idea to a working model is big enough; but the step from the working model to the marketable commodity is often even bigger; and even when the marketable commodity has been produced there remains the work of bringing it before the notice of the public, *i.e.* the consumer.

The inventor must realise these facts, and must realise, too, that it is impossible for he himself to handle his invention single-handed through all these stages, if success is to be achieved. He must either sell the idea for what it will fetch as a vendable patent, or work on it himself until he has succeeded in developing a saleable working model.

He will probably find that the

market value of a mere idea is simply nothing, even if it is patented. A patent, unless backed by some sort of demonstration, or by some sort of working apparatus is one of the most unsaleable commodities in existence; and the very action of offering his device for sale may prove his undoing. The parties to whom the patent is offered may seize upon the underlying idea, and may themselves utilise it while avoiding the actual claims covered by his patent specification.

The inventor's best plan is, if possible, to develop his invention to the stage where he can show results; then, if he can, to interest a financial syndicate, first taking care that his own interests are safeguarded by first-class legal advice. During the course of the negotiations, also, he should take care that he is not too greedy in his demands, but leaves scope for those who are finding the money to participate to a reasonable extent in the prospective profits resulting from the future commercialisation of the invention.

From a purely scientific standpoint the plan of giving full publicity to all the technical details involved is a course no doubt to be commended. From a commercial standpoint, however, this policy is most inadvisable, and the premature publication of such technical details as would assist rival concerns should be carefully avoided.

Publicity is unavoidable when patents are published, but it should be borne in mind that any information divulged prior to the publication of the patent, or even the issuance of further details not given in the patent specification, amounts simply to the giving away of valuable property to others who may be potential rivals.

Hear the rousing music of massed bands

— with a
**LISSEN
BATTERY**
in your Set

You can almost hear the stamping feet of marching soldiers as martial music floods your room— you get the spirit of the massed band festival as you listen with a Radio set whose power is supplied by Lissen Batteries. You hear the delightful blending of all the many instruments because the pure D.C. current of the Lissen Battery is noiseless, abundant and always smooth flowing, providing power for your valves such as you never had before and can never get in any other way, because the new process and chemical combination known only to Lissen is embodied only in the Lissen New Process Battery.

Buy this fine Battery at one of 10,000 Radio dealers, and show plainly by the way you ask for it that you mean to have a Lissen and no other.

60 volt
(reads 66 v.)

7/11

100 volt
(reads 108 v.)

12/11

60 volt
(Super Power)

13/6

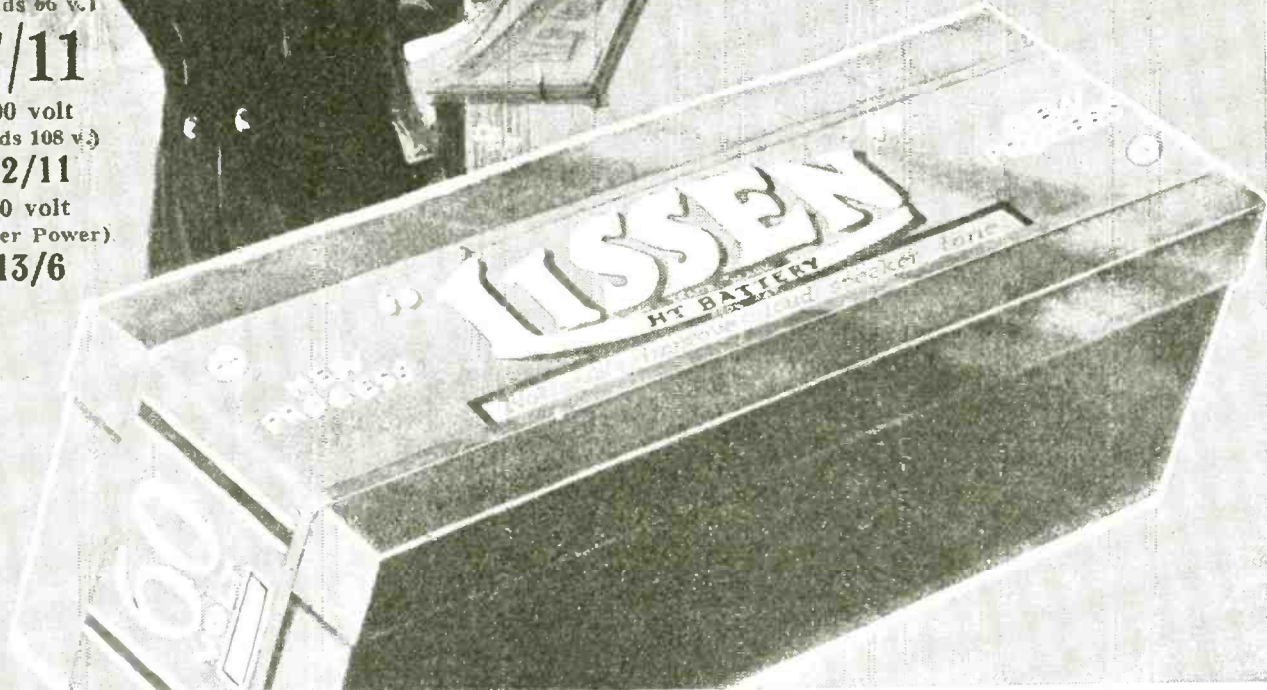

LISSEN LIMITED (Managing Director: THOS. N. COLE), FRIARS LANE, RICHMOND, SURREY
Mention of "Television" when replying to advertisements will ensure prompt attention.

L A N G H A M R A D I O



AN OUTDOOR PLEASURE!

FOR picnics, for after-tennis idling, for afternoons and evenings on the river, the Langham Portable Radio Receiver supplies a pleasant background of broadcast music that harmonises with the summer mood.

The tone of its loud-speaker reproduction is acknowledged to be perfect; a continental range at full strength is guaranteed; and it is simplicity itself to tune.

No other radio receiver is so complete, so handy, and so truly portable—and you can have one on a week's trial before you decide to buy!

Write us for full particulars now.

ONLY £6 DOWN

complete and absolutely ready for use—balance by small instalments, or 35 Guineas cash.

Guaranteed for Two Years.

LANGHAM RADIO,
Rosslyn House, 96, Regent Street, London, W.1.
Telephone: Gerrard 9676 (six lines).

The
LANGHAM
Portable Radio



The Villager Looks Around

By Charles Jones

HOW often has a small boy bitten a penholder inches shorter in cogitating over that chestnut of the homework tasks, "State the advantages and disadvantages of town life as compared with country life"?

He writes, as his fathers did before him, of a perfectly imaginary townsman hastening about great business in fast vehicles, making a rapid way to fortune, and in his spare time, consuming libraries of literature, hunting through museums, and witnessing wonderful productions of *Hamlet*.

To the countryman he allocates a pretty cottage, birds (implying nests), and the soil. I have written a "composition" like that, but I fear the venerable practice will die out with my generation. The villager is not so much at the circumference of things as he was. For some time past a tide of humanity has flowed from country to town, for reasons both within and without the purview of harassed young essayists, but the ebb will set in, if indeed it has not already done so.

Even neglecting the modern facilities for travel and the distribution of goods, there is little doubt that if the city culture is carried to the country cottage it will revolutionise the distribution of humanity.

An Age of Expectation.

We are living in a phase of expectation. Already, unimaginable music is carried to our country hearthsides. Instead of the village crier ringing his bell and announcing the lore of the local pump, we get the tuning note for the world's news. We have no theatre, but, after the business of discussing roots is at an end, we can at least hear a play spoken by discarnate voices. Though somewhat removed from the babel of a resettling world, and mainly concerned with cows and corn-crops, we catch echoes from the far-off cities.

An ambassador pleads to us for the comity of nations; an university of learning is close up to our aerials; and the jackanapes of the music rails round off our quiet evenings with a laugh.

The Countryman Imbibes Science.

The countryman was a little shy of this electric entertainment at first. There was an impression that wireless was an eruption of the supernatural into our work-a-day world. But nowadays the very parson talks "atoms" and biology from the village pulpit, because it is patent that wireless, among other influences, has immensely widened the intellectual scope of the average man of limited opportunity. London calls, and the Oxford accent breaks loose in the rural High Street.

In the midst of this excitement the organ of the Television Society is launched upon us.

This promise of a new dimension to life, making the whole round earth a vision, fills us with impatience. It will abolish the last limitation, and bring the crowded streets into the lanes, and take the hedgerows for the refreshment of the city. The youngest of us is eager for this new power—seven-league boots for feet hampered with the clod, a magic carpet to lift up the last slaves of pedestrianism.

We are not concerned with the scientific side altogether, for the mechanism of miracles is not the chief concern of men whose business is in green fields, and to whom the sky is the final mystery. It is just the sheer wonder of it that grips us. The things we have heard with our ears reveal a world beyond our world.

I know men and women whose lifetime has passed all in the shadow of a single hill, to whom the music emptied into the ether night by night, and caught on threads stretched from some garden elm to a lamp-lit window, is a free-

dom to a new world altogether. The gigantic gesture of the broadcast has brought music, the language of the people, out of its dark corners in the city halls into the valleys and green spaces where it was born. We find that the voice of the violin now compasses unutterable things. And the orchestra! The overwhelming cry of the full majesty of genius is sent out to men under lowly roofs to whom it were otherwise dumb. It is a thing to thank Heaven for.

Now we are impatient for the crowning wonder. Beauty is hidden in other places, sealed up in immovable stone, localised in picture and ballet and drama, perhaps walking free in far ends of the earth. When will the magicians spread out the panorama of the world for us to see? We know it will come. Our children will have their fairy tales hung out in middle air where they belong.

And, when the children are abed, we shall walk in strange lands and see the seven wonders. It will be very pleasant to see and hear Mass in the great Church of St. Sofia; to come from winter fields to the coral islands of the southern seas; to follow explorers to the poles, and open the picture-book of Asia. What a breakdown of frontiers! Out of the village and across the hemispheres!

Hasten, You Men of Science!

We hear of small beginnings, but our confidence in the magicians is sure. We wait . . . but hasten, you men of science . . . we wait for the colour and changing beauty of city and mountain and sea, and we know that our dreams will all come true from that very air where, hitherto, we have built our castles.

The schoolboy of the future will head his sheet with the old title, "State the advantages . . .," and, thanks to television, give us the finished work of an explorer.

The Power of Optical Instruments

By Professor CHESHIRE, C.B.E., A.R.C.S., F.I.P.

THERE is considerable confusion in the minds of many people as to what the "power" of an optical instrument really is, as witness the following story: "Has this telescope a range of fifty miles?" said a potential customer to a sharp shop assistant. "Fifty miles, Sir!" replied the assistant, "why it has a range of two hundred thousand miles! *You can see the moon with it!*"

In the case of the smaller telescopes, used for terrestrial purposes, as also for the microscope, when used for simple low-power work, the power is usually expressed as a "magnifying power of eight (say) diameters." This expression in the case of a telescope, used on a distant and inaccessible object, means that the apparent or angular size of the image of the object presented to the eye is eight times that of the object seen directly. The moon, which subtends an angle of half a degree, as seen with such a telescope, would subtend an angle of four degrees.*

Magnifying Power.

In the case of the microscope the apparent size of the image presented to the eye is compared with the apparent size of the object, placed at the so-called distance of distinct vision, usually taken as ten inches. As, however, in this case the magnifying power is commonly determined by projecting the image with a camera lucida on to a screen ten inches away, and there comparing it with the linear dimensions of the object itself, the word "diameters" is used. Magnifying power, however, should always be thought of as the ratio of two angles—one the angle under which the image of an object is seen, and the other the angle under which the object itself is seen when observed and examined in free-vision.

Something more than magnifying power, however, is requisite in an optical instrument. Some time ago a lady showed us a beautiful pair of opera glasses—all pearl and gold—which she had just purchased at

a sale. We were suspicious, and asked for permission to test them. They had a magnifying power of two-and-a-half times, it is true, but an advertisement could be read at a greater distance away with the unaided eye than with the opera glasses!

An optical instrument, such as a telescope or a microscope, is judged ultimately by its power to give a

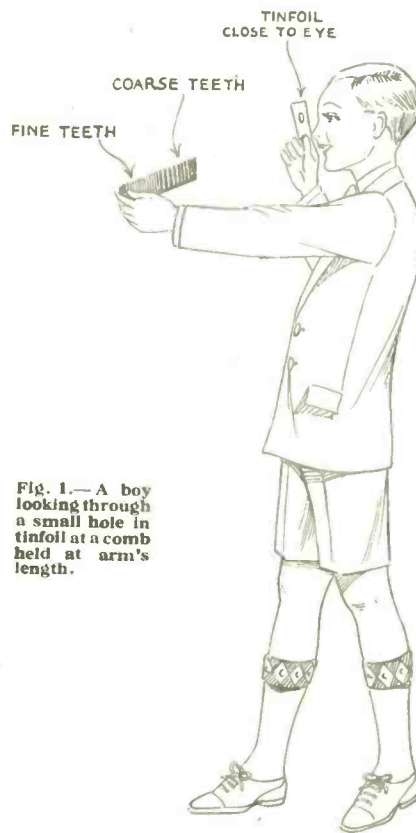

Fig. 1.—A boy looking through a small hole in tinfoil at a comb held at arm's length.

true picture of an otherwise invisible structure; or, in other words, by its *resolving power*.

The Resolving Power of the Eye.

A simple and striking experiment, to demonstrate the limitation of the power of the eye to see and differentiate fine structure, can be carried out as follows: Take (1) a common comb provided with closely-spaced teeth for one-half of its length, and with

more coarsely-spaced teeth for its other half, and (2) a square inch or two of tinfoil, or a visiting-card will do. Prick a number of holes of different sizes in the foil with a *fine* sewing needle.

Now hold the comb at arm's length, as shown by Fig. 1, and look at it with one eye (closing the other) through the different holes. Through the larger of these holes both sets of teeth will be seen distinctly, but through the smaller holes, if small enough, one or more will be found through which the coarser teeth only will be seen individually. In the case of the finely-spaced teeth the individual teeth cannot be seen. Instead of clear resolution a streaky blur occurs over half the length of the comb.

A Simple Experiment.

If now the comb be moved slowly towards the eye, the finer teeth will at a certain definite distance away almost jump into resolution again and remain so for all nearer distances. On the other hand, by moving the comb away from the eye, or rather by getting someone to do so for you, a distance will be found at which the coarser teeth pass out of resolution into a jumble.

This experiment shows—to put it into a commonly-understood form—that the number of lines per inch that can be resolved, or seen distinctly, at a given distance depends upon the virtual diameter of the pupil of the eye, since the function of the hole in the foil is simply to determine this virtual diameter, i.e. the aperture of the lens projecting on to the retina.

This experiment can be simplified with profit by dispensing with the perforated tinfoil and using the unaided eye. To do so, draw a number of pairs of parallel lines with black ink on a piece of cardboard. Let the distances apart of these pairs of lines vary from the one-hundredth to the one-tenth of an inch. Pin up the card in a good light, and then walk backwards from it until the less

* It is useful to remember that the apparent size of a threepenny bit, held at arm's length, is about twice that of the moon, since it subtends an angle of about one degree at this distance.

widely-separated pairs of lines run together and thus pass out of resolution. Note the distance at which this occurs. Repeat the experiment for each of the other pairs of lines.

Calculate for each case the value of the fraction obtained by dividing the separation of the two lines, in inches, by the maximum distance away, also in inches, at which resolution occurs.

Calculating Resolving Power.

For a normal eye this fraction will be found to approximate to 1/3000 in every case. We learn from this experiment that the smallest angle in circular measure under which a normal eye can see as separated a pair of parallel lines is of the order of 1/3000.

On a straight run of railway, for example, the rails will appear to run into one another at a distance of three thousand times their separation, if the seeing conditions are good; or, again, a 250 lines-per-inch screen should be seen resolved at a distance of twelve inches.

Before passing on to consider the question of the power of such familiar instruments as the telescope and the microscope, it will be well to consider first the simplest possible case of optical projection.

Fig. 2 is the reproduction of a pin-hole photograph, magnified about twenty times, taken by the late Sir William Abney in mono-chromatic blue-light, with a wave-length of 0.000183 inch. The object was a circular hole, 0.005 inch in diameter,

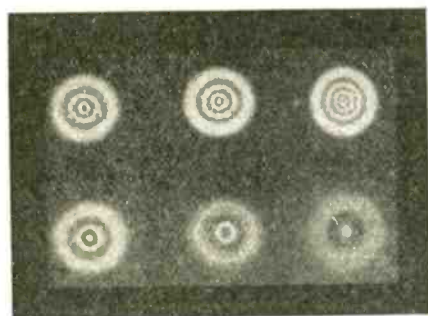

Fig. 2.—Images of a point source of light produced by a pinhole (Abney).

placed 24 inches away from the pin-hole, which had a diameter of 0.042 inch. Six photos were taken with the plate placed in succession at distances away from the pin-hole equal to 3.5, 4.2, 5.2, 6.8 and 9.5 inches.

The first of these photos is shown

at the top right-hand corner of the figure, and the last one, No. 6, immediately below it; the numbering in the top line running from right to left, and in the bottom line from left to right.

In the first of these it will be seen that the image consists of a small central dark disc, surrounded by concentric rings, alternately bright and dark—four of each. These rings diminish in number as the distance of the plate from the pin-hole increases, until, in the last photo, No. 6, taken at a distance of 9.5 inches, the central bright disc is surrounded by one dark ring, and one bright ring only.

It is significant, too, that the central disc in this series of photos is alternately bright and dark. If these photos had been taken with light of a greater wave-length—red, say—the same kind of image would have been obtained, but the rings would have been relatively larger.

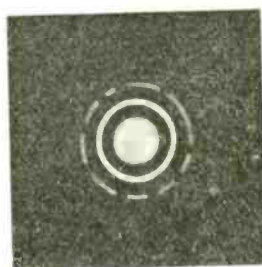

Fig. 3.—Perfect star image as given by a modern astronomical telescope.

We will now pass on to consider the image of an object-point produced by a lens system.

A Perfect Star Image.

One of the most perfect images produced by optical means is that to be found in a first-class modern astronomical telescope, directed to a star which is so far away that it acts as a point-source of light. Here again we find, as in the case of the pinhole, not a point but a central bright disc surrounded concentrically by dark and bright rings.

Fortunately, however, in the case of a well-corrected telescope object-glass the central disc contains about 84 per cent. of the light available for image purposes, with the result that the bright encircling rings are so weak that not more than one or two can be seen under normal conditions. Fig. 3 shows such an image.

We cannot, for considerations of

space, enter into the question as to how it comes about that the most perfect attainable image of a point is a disc of appreciable magnitude, fading away in intensity from

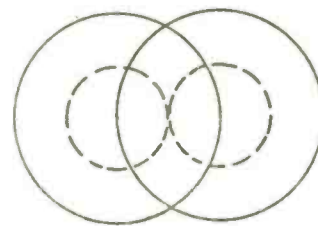

Fig. 4.—Overlapping of image discs of stars in telescope.

its centre to its margin. It may be said, however, that it follows at once, as was shown by Airy nearly a hundred years ago, from Huygen's wave-motion theory of light, supplemented by the principle of interference advanced by Young at the beginning of last century.

Calculating the Radius of a Star.

Airy showed by a brilliant piece of mathematical work that the radius *r* of the central disc is given by the equation:

$$r = 1.22 \frac{f\lambda}{D} \dots (1)$$

where *f*, is the focal length of the object-glass, *λ*, the wave-length of the light considered, and *D*, the diameter of the object-glass.

It is important to notice here that from this equation it follows that the size of the image of a star in a telescope varies inversely as the diameter of the object-glass—the bigger the telescope object-glass the smaller the star image.

Let us see what the effect of this is upon the resolving power of an object-glass.

The resolving power of the Yerkes telescope, which has an object-glass forty inches in diameter, is said to be about one-eighth of a second of arc. By this it is meant that two stars, so near together in the line of sight that they subtend an angle of one-eighth of a second, can be just seen as two stars. This state of affairs obtains when the star discs overlap, so that the edge of one passes through the centre of the other. See the circles in full lines, Fig. 4.

If now we could, as may possibly be done in the future, use an object-glass of eighty inches in diameter, without altering the focal length,

(Continued on page 36).

Selenium

Its Chemical and Microscopical Characteristics

By JAMES SCOTT, F.R.S.A.

NOW that the newly popularized science of television is represented by its own monthly journal, the name selenium is also coming forward to general notice. Yet how many people, apart from scientists and technologists, are aware what this substance really is?

It is procurable in sticks which are intended to be used after the manner of sealing-wax, namely, over a heated surface, in order to prepare a cell.

Selenium is really one of the most remarkable materials known; yet only a few years ago it was regarded, even in chemical circles, as rare and of but little, if any, practical use. In 1886, for instance, one of our leading professional writers stated that, "These elements are scarce and unimportant." He included tellurium in this opinion. But we are going to hear quite a lot of selenium in the future, as television advances in perfection and public appreciation. Hence, it is advisable for people to learn something concerning its nature and character.

The Nature of Selenium.

Selenium is classified in laboratory literature as a member of the subgroup in which the companion elements are oxygen and sulphur. This is a peculiar fact, because oxygen is an invisible gas. Everybody knows what sulphur is, though only the scientist is aware of its remarkable variations in structure, upon which it would be inappropriate to dwell now. It needs stating, however, that selenium only resembles sulphur in so far as it is capable of crystallizing in more than one particular formation; and of reacting similarly with regard to associated substances.

The origin of selenium is traceable back to some continental smelting works, in the furnaces of which occurred a red substance occasionally among the products derived from the

treatment of certain mineral ores. At that time the item was regarded as useless, and a nuisance. But someone was tempted to investigate the matter, and it was ultimately found to be worth continued study and testing.

The discoverer of its peculiar light-sensitive properties, Mr. May, a telegraph operator, placed selenium in the ranks of important substances, and it will undoubtedly be heard of a great deal in the near future.



Fig. 1.
Greatly magnified view of the normal edge of slab-selenium which has been cast in a shallow mould in a molten condition.

It was learnt that selenium would act with electric current only in darkness, so that it has served for quite a long time automatically to light many buoys at sea, which become illuminated, aptly enough, at night-time.

It is for this reason that the electrician says that selenium has its resistance reduced by the action of light, which can thus be made to activate it to widely varying degrees, according to the intensity and brightness of the rays.

Selenium, though it is not actually a metal, certainly has many characteristics which justify its being classified as such. Therefore, it is put in a group known as metalloids. Strangely

enough, it can be made to present a phase which would be considered by the majority of persons to be a metal, since it has all the appearance of one—namely, steel—whereas in another phase, just as easily accomplished, and in a short time, it discloses an aspect almost like that of wax, being then very dark greyish-brown, called *black*, and brilliantly lustrous.

It can be resolved into either a black or red solid condition; the first-named form being minutely crystalline, although the second is amorphous or shapeless in structure. But a crystalline modification can be obtained in the black variety, if the proper course is adopted in connection with it.

The Different States of Selenium.

Its changes all depend on the precise temperature at which the selenium is heated, or melted; the rate of heating and of cooling, the quantity of air enveloping it, and other incidents. What may be called the ordinary melting point is 217° centigrade.

These different states behave in special individual ways, when in contact with chemical solutions of various characters.

None of the potent facts which bear upon it should be discarded, for it is quite as likely that one or more of them will possess valuable features in the future, just as light-sensitiveness was found to exist, though it had hitherto not been suspected.

Strictly speaking, the value of selenium depends on its photo-conductivity, as contrasted with the power of photo-emissivity, to which class the photo-electric cell belongs. These terms are likely to have an abstruse complexity among amateurs, but in a broad manner of speaking—I am not meaning at the moment to be exact in definition, since that is difficult without proper phraseology—photo-conductivity may be com-

pared with a glowing fire; and photo-emissivity with a sparking fire—both radiate heat; one quietly, the other energetically.

Selenium cells as at present constituted possess a percentage of inertia; but no doubt some means will shortly be discovered whereby this serious fault (from a television point of view) will be eradicated, and the cell composed of it will be re-invigorated, as it were.

In connection with my microscopical observations on selenium, it is worth bearing in mind the fact that the thinner the layers of selenium are in a cell the more efficient become the working capacities of the latter. The reader will probably be aware that the selenium stick is rubbed over hot glass for the purpose of melting it; precisely in the same way that sealing-wax is used when a deposit is required anywhere.

Importance of a Thin Layer.

Now it is very obvious to all thoughtful people that if the thinnest possible of selenium films acts better than a thicker one, any unevenness would be detrimental to its qualities, because that state would imply that some portions were denser than the remainder.

We have to remember that the proper functioning of "vibratory" mechanism depends to a very large extent on microscopical features, so that amplification, whether it be prepared for audible reception or visual contemplation, will of course tend to increase the volume of any faults.

The principle involved is analogous to that concerning the projection of

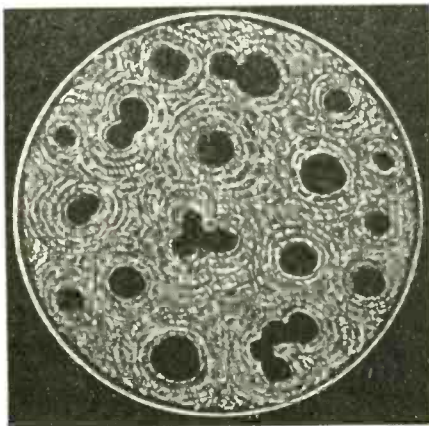

Fig. 2.

Greatly magnified view of a fractured edge of a selenium slab in a "waxen" or brilliantly glossy condition. Its pores are concentrically grooved and ridged.

large pictures on a screen from a cinema or magic lantern. Specks invisible to the naked eye on the film, or the slide, are rendered conspicuous on the stage or platform.

The Results of Microscopic Flaws.

We can have minute "sounds" only audible to animals like dogs; minute "sights" only disclosable through the microscope; minute electric currents only registrable by means of the voltmeter; minute rays of light only visible to a sensitive camera-plate; minute drops of perspiration on our flesh, which the doctors call *insensible* (it is not noticed) as distinguished from obvious sweat.

Conversely, we must believe that minute blemishes can become responsible for *amplified* faults, while minute merits, as their increase is assured, help forward the most perfect of *amplified* results in every direction of industry.

We must not only use our material satisfactorily, e.g. selenium, but be sure that its quality, treatment, and experiences are of the best obtainable order.

In Fig. 1 is shown a magnified view of the plain, smooth edge of a piece of selenium slab, cast in a shallow mould. The crystallization reminds me of some spicular phases of sulphur, which, like the substance now being treated, is allotropic, a name which means that it is capable of crystallizing or re-forming its minute particles, in several different shapes. In very bright light this spectacle is less clear!

Structure of Selenium in Different States.

I found that the smooth, highly shining top-surface of the slab was almost devoid of anything at all interesting to the layman along the directions I was seeking, that area being but very slightly pitted or mounded and faintly scratched or scoriated.

Reflecting for a few moments on these facts, it would seem to be quite possible that the structure of a film of selenium would be *minutely* different where it came into direct contact with the surface of the glass, or other material used with it, from the outer, or free, portion exposed to the atmosphere or other body.

In Fig. 2 is shown the magnified appearance of the fracture of

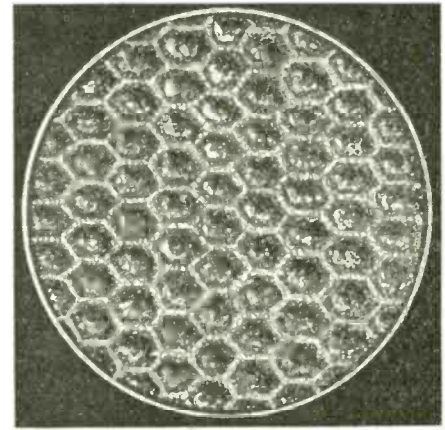

Fig. 3.

View, enlarged many times, of metallic selenium, in which condition it resembles (to the naked eye) steel and iron. This is a perfect example.

selenium; the slab having been broken. Largely considered, the fractures are conchoidal or shell-like.

In Fig. 3 is shown the magnified formation of the "metallic" phase of selenium, obtained simply by heating some of the "waxen" variety. This will give the reader an idea of its unique attributes, and an insight into its possibilities. Without care this phase may become polygonal.

When a thin film of any substance, e.g. gold leaf, which is *then* of a green colour, is held up to the light, it is disclosed as being composed of various shaped particles. In instances where *sensitivity* is concerned, these features cannot help exerting an influence, either for good or evil.

Special Notice of Meeting OF THE

TELEVISION SOCIETY

AT

THE ENGINEERS' CLUB
Coventry Street, W.C.2

ON

Tuesday, May 1st, 1928
at 8.30 p.m.

LECTURE ON TELEVISION

by Mr. J. L. BAIRD

As the accommodation is limited the Honorary Secretary will be glad if you will kindly notify him of your intention to be present in order to secure seats for your self and friends, not later than April 30th, otherwise there may be difficulty in arranging seats.

J. DENTON,

Hon. Sec.



Visible Speech across the Atlantic

By

Lt.-Col. CHETWODE
CRAWLEY, M.I.E.E.

(Deputy Inspector of Wireless
Telegraphy, G.P.O.)

THERE seems to be some mysterious bond between vision and speech and Scotsmen. Clerk-Maxwell, a Scotsman, said of Alexander Melville Bell, a Scotsman, "He brought the art of visible speech to such perfection, that, though a Scotsman, he taught himself in six months to speak English, and I regret extremely that when I had the opportunity in Edinburgh I did not take lessons from him!"

Melville Bell's son, Alexander Graham Bell, was born in Edinburgh, was a teacher of visible speech, and in 1876 introduced the telephone to the world.

In 1928, Mr. John Baird, a Scotsman, televises across the Atlantic. "Televises" may not suit the purists, but neither does "television." Telephone, microphone, gramophone, telegraph, telescope, and telepathy suit him all right, but "teleopsis" would no doubt have been his choice of a name for television.

Television is more than visible speech; but it is as a form of visible speech that it will first come to its own—i.e., by making visible the distant speaker. The speech and the vision may be conveyed over world-wide distances by the ether of space, and it may be interesting to glance at the latest developments in conveying speech, and to consider how these developments bear on similar methods of conveying vision.

Practical long-distance radio-telephony was born, like its parent radio telegraphy, in Italy when in 1912, Prof. Vanni transmitted speech

over 1,000 kilometres between Rome and Tripoli. But it was not until the close of 1915 that the world in general sat up and took notice when spoken messages were first sent across the Atlantic from Washington to Paris, just as it again sat up and took notice when Mr. Baird televised from London to New York early in 1928.

Unfortunately for radio-telephony the world was busy with other matters in 1915, and little more was done with long-range working until 1923, when the American Telephone and Telegraph Company, which had made the 1915 tests, again demonstrated the possibility of telephoning across the Atlantic, this time from America to England. This demonstration caused a great sensation in England, at any rate amongst radio workers; the British Post Office decided to co-operate, and a long series of experiments was commenced in conjunction with the

American Company and with what is now the International Western Electric Company. Eventually a 200 kw. radio-telephone transmitter was installed at the Post Office Station at Rugby, where 820 ft. masts were available, and a receiving station with directional aerials was erected at Wroughton near Swindon.

First Two-Way Conversation.

Two-way telephony across the Atlantic was achieved for the first time on February 7th, 1926. The first message exchanged consisted of the not very epoch-making remark: "Hullo! New York," from England, and the even terser, if more personal, reply from America—"Bailey." Bell was as personal but a little more expansive in his first telephone message on March 10th, 1876, when he ran to seven words: "Mr. Watson, come here. I want you."

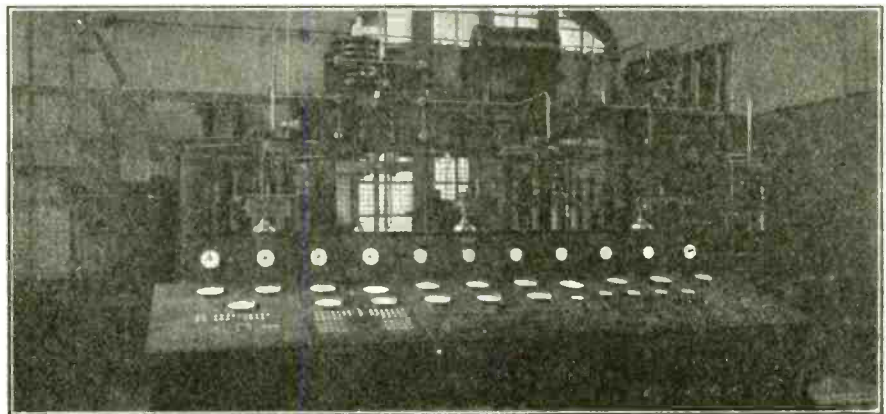

Control Table and Valve Ampuners at Rugby.

During the early days of two-way telephony across the Atlantic, the waves used on each side were different; but due to the congestion of waves available for long wave radio working a most ingenious system was devised by which each transmitter used the same wave, and on January 7th, 1927, a commercial transatlantic service was opened.

A period of eleven years had elapsed between the demonstration of the practicability of telephoning across the Atlantic and the opening of a commercial service; so we must not be too impatient with the progress of television, though we need not forget that it was only during the latter three of those eleven years that the telephone problem was really seriously tackled.

Service Now on Sound Commercial Basis.

The transatlantic telephone service is now on a sound commercial basis, as evidenced by the fact that the service has recently been extended to various parts of Western Europe on the one hand, and to Canada, Cuba, and all over the United States on the other; and by the fact that in February it was found possible to reduce to £9 the original minimum charge of £15 for a three minutes' conversation.

The transmitting station in England remains as originally at Rugby, but the receiving station is now at Cupar, in Fifeshire, as it was found that atmospheric interference was much less in the north. On the other side, the transmitting station remains at Rocky Point, 75 miles from New York, and the receiving station at Houlton, Maine, 600 miles to the north. The wave used is still between 5,000 and 6,000 metres.

Such a long wave is not at all suitable for television, and it will be remembered that Mr. Baird used a short wave of about 45 metres in the transatlantic tests, a fact which in itself means that the special work done on the purely wireless part of the telephone service will be of

only limited assistance in the development of television, though the experience gained in connecting the wireless circuit to the land lines will of course be valuable.

What this great achievement of transatlantic radio-telephony already means may be realised from the following motion which was proposed on February 16th last by General Carty in New York, seconded by Sir Oliver Lodge in London, and carried unanimously:—



The Aerial Lead-in at Rugby.

Societies Meet Across 3,000 Miles of Ocean.

"Whereas on this sixteenth day of February, 1928, the members of the Institution of Electrical Engineers assembled in London, and the members of the American Institute of Electrical Engineers assembled in New York, have held, through the instrumentality of the transatlantic telephone a joint meeting at which those in attendance in both cities were able to participate

in the proceedings and hear all that was said, although the two gatherings were separated by the Atlantic Ocean; and as this meeting, the first of its kind, has been rendered possible by engineering developments in the application of electricity to communication by telephone; therefore;

"Be it resolved that this meeting wishes to express its feelings of deep satisfaction that, by the electrical transmission of the spoken

word, these two national societies have been brought together in this new form of International Assembly, which should prove to be a powerful agency in the increase of good will and understanding among the nations;

"And be it further resolved that a record of this epoch-making event be inscribed in the minutes of each society."

At this historic joint meeting the remarks of the American members were made audible to the English members through loud-speakers in the lecture hall in London, and the remarks of the English members were heard similarly in New York.

Television will Utilise Short Waves.

When will the first joint meeting take place where the members can see each other as well? All one can say is that when it does take place it is pretty sure to be brought about by the use of a short wave in place of the long wave used for the meeting of February 16th. Great Britain was the first country to open up satisfactory long-range radio-telegraph services on short waves by utilising the beam system. This system is not yet in commercial operation for telephony or facsimile transmission, but there is no reason to expect that advance along these lines will be long delayed, or that such advances will not pave the way later on to commercial long-range television.



LAST month we concluded our description of a simple televisor, which consisted of a transmitter and receiver combined, so that in consequence problems of synchronisation were not involved.

It is now proposed to show how, by building a separate receiving machine and by slightly modifying the original apparatus to form the transmitter, simple shadowgraphs may be transmitted over any distance. Two leads of twin flex form the sole connection between the two machines (one to carry the shadowgraph signals and one to carry the synchronising current), as the amateur would hardly care to go to the trouble and expense of fitting up a wireless transmitter and receiver for the purpose of transmitting the signals by wireless.

The Method Employed.

The method to be employed is briefly this: Instead of placing the neon tube behind the same spiral disc that is used for analysing the image, it is now going to be placed behind a second disc which may be situated at any desired distance away from the transmitter. Now, however, in order to see an image we must ensure that this second disc revolves at exactly the same speed as the first disc and continues to do so. In other words, the second disc must revolve in *synchronism* with the first disc.

One method of obtaining synchronism would be to control the motor driving the second disc with a fine control rheostat until the two discs were exactly in step. This is a very simple method, but constant readjustment is called for; the slightest variation will upset the received image.

The method which will be described here consists in using to drive each of

the spiral discs a D.C. motor coupled to a small A.C. generator. In the apparatus to be described two 200 w. W/T Newton motor-alternators were used, as these happened to be available, but any small motor-alternators would be equally suitable.

If Newton motor-alternators are used the connections will have to be traced out as the generator and D.C. motor are combined and housed in one aluminium shell. The field current for the A.C. side must be supplied between the centre carbon brush at one end of the spindle, and the frame. Field and armature connections are easily traced and the insertion of a 2 ohm variable resistance in the armature circuit will enable the speed to be controlled. A 6-volt accumulator will supply ample current for the purpose. The A.C. output comes from the two vacant plug holes in the ebonite block screwed to the side of the machine.

The first experiment to try is to mount a spiral disc on the spindle of

each alternator and connect the A.C. sides together, putting a small 3.5-volt flash lamp bulb in the circuit (see Fig. 1). A single-pole knife switch should also be arranged so that the small bulb can be short-circuited. Now supply about 6 volts (derived from the accumulators used to drive the D.C. motors) to the A.C. fields and set the motors going. Leave the shorting switch open and watch the small bulb. It will be seen to be flickering.

Synchronism Adjustments.

Now adjust the speed of one of the motors by varying the series armature resistance until a speed is reached when the bulb flickers at as slow a rate as possible; it should remain out for three or four seconds. While it is out close the knife switch, shorting the bulb. The two motors will now remain exactly in step, provided the original adjustment was sufficiently close and the knife

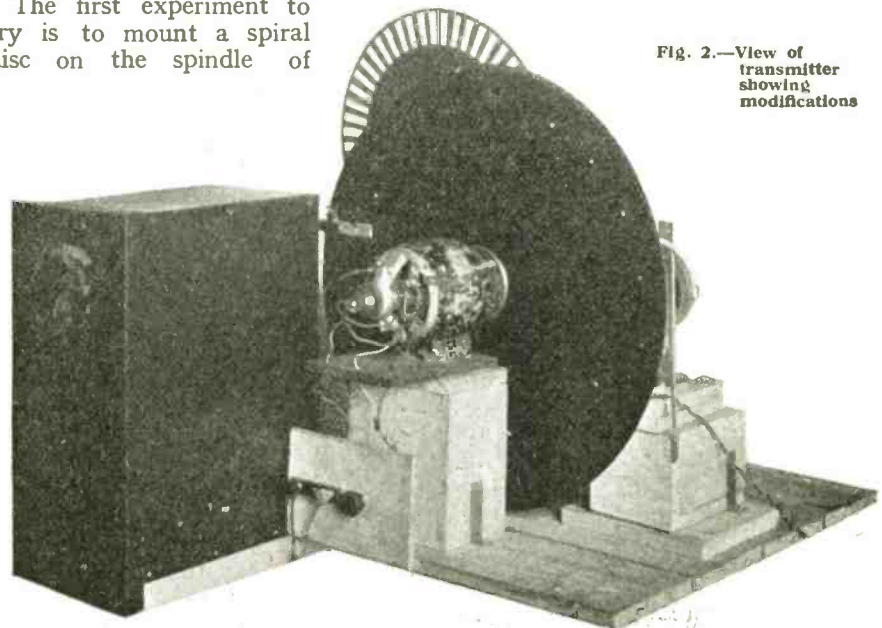

Fig. 2.—View of transmitter showing modifications

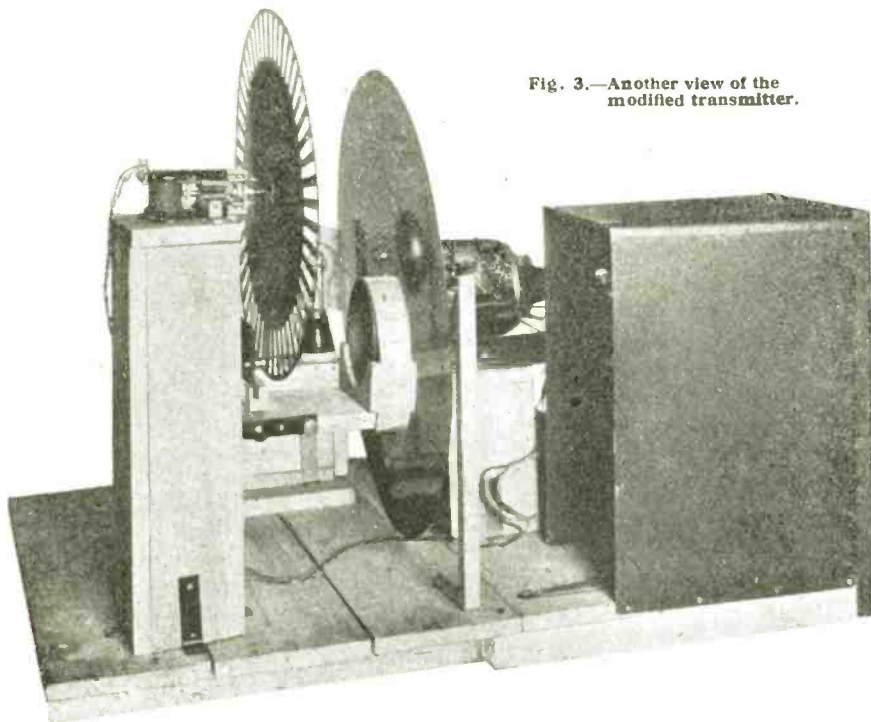

Fig. 3.—Another view of the modified transmitter.

switch was closed at the correct instant.

If the two motors are observed both to slow down on shorting the bulb, this indicates that they are not synchronising, and the switch should again be opened and the adjustments repeated more carefully until success is achieved.

Having got the two discs revolving exactly in step the main difficulties are at an end. The connecting lead between the alternators may be of any desired length, and the flash lamp bulb and shorting switch may be conveniently mounted near the receiving apparatus.

Connections from Amplifier to Neon Tubes.

All that now remains to be done is to transfer the output leads from the amplifier to a neon tube which will be placed behind the receiving disc. This is most conveniently done by having a double-pole double-throw knife switch arranged so that the output from the amplifier may be thrown at will either to the neon tube on the transmitting machine or to the distant neon tube behind the receiving disc. This is for convenience, so that the amplifier may be adjusted by throwing over to the neon tube behind the disc at the transmitter, and then throwing the switch over so that the distant neon tube is illuminated, when the image should come through perfectly.

The amplifier and neon tube connections are the same as described in our last two issues.

Structural Alteration to Original Machine.

(See Figs. 2 and 3.)

As will be seen from the photo, the original pedestal supporting the four-volt motor driving the spiral disc has

Fig. 4.—View of the receiver, the lay-out of which is of the simplest character.

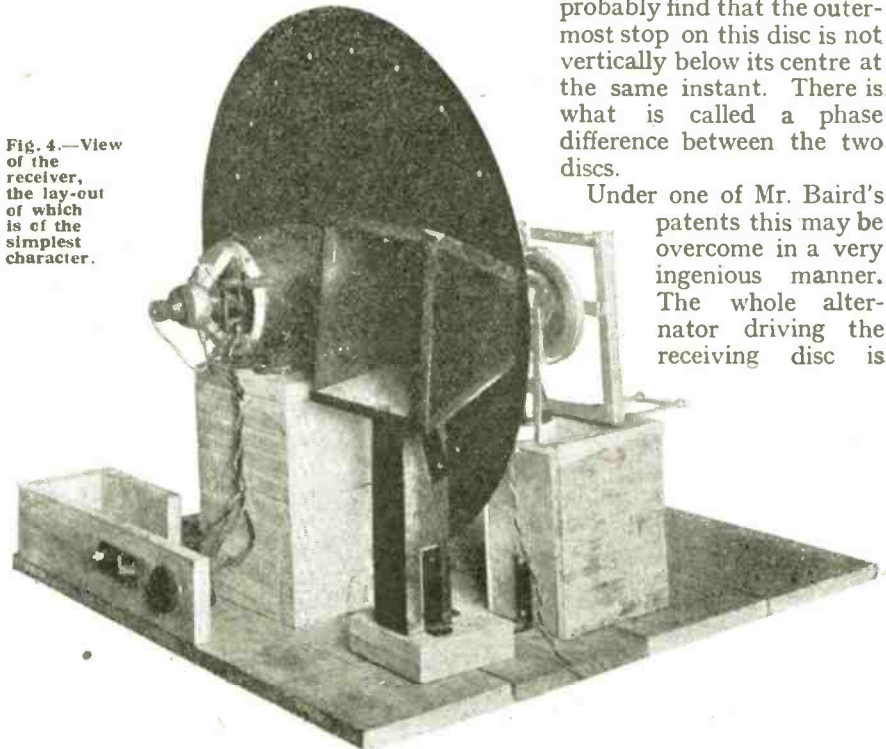

been reduced in height to 8 in., and a Newton motor-alternator mounted thereon, carrying the original spiral disc on its spindle. The addition of a double-pole double-throw knife switch from amplifier output to neon tube completes the list of alterations, the interruptor disc and motor, selenium cell, projector lamp, etc., being retained intact.

Receiving Machine.

Obtain or make another spiral disc exactly similar to that at the transmitting end and mount it on the spindle of another similar motor-alternator. Prepare a wooden baseboard about 18 in. by 24 in. and mount the alternator and its attached disc on a pedestal (about 8 in. high) fastened to the baseboard.

There now arises a point to which the amateur may care to devote some attention. While it is possible to get the two discs revolving at exactly the same speed, there is no guarantee at all that corresponding parts of the two discs will, at any given instant, be in corresponding positions.

To make this clearer, consider either of the two stops on the transmitting disc furthest from its centre. At some instant one of these stops will be vertically below the centre of the disc. Now, if we turn our attention to the receiving disc, running at exactly the same speed, we shall most probably find that the outermost stop on this disc is not vertically below its centre at the same instant. There is what is called a phase difference between the two discs.

Under one of Mr. Baird's patents this may be overcome in a very ingenious manner. The whole alternator driving the receiving disc is

mounted so that its body may be rotated through any angle, and if this be done slowly, say, by means of a handle operating through worm gearing, it will be found that the phase difference can be corrected without upsetting the synchronism. Obviously the use of a jerky or rapid motion will put the discs out of step. The effect on the received image of this "phase difference" is to displace it sideways to left or right, so that it is part in, part out of the field of view.

The effect is similar in many respects to the corresponding effect sometimes seen in a cinematograph theatre where a black bar appears across the screen. Above this bar a portion of the picture appears, and below it another part of the picture is seen. The only difference is that in this case the displacement of the image is in a vertical direction instead of sideways.

In the machine shown in Figs. 4 and 5 this phase-correcting refinement has been omitted for the sake of simplicity, but the amateur who cares to try it should find no difficulty in designing a simple arrangement to suit his own motor-alternator.

In the photo there will also be seen a neon tube on a pedestal, behind which is placed a 4-in. concave mirror, and in front of which is a ground-glass or ground gelatine screen. This neon tube is connected at will through the D.P.D.T. knife switch previously mentioned to the output of the amplifier.

This completes the receiving set, which will be seen to be a comparatively simple piece of apparatus.

General Remarks.

The experimenter will soon find that the simplest way to get his discs synchronised is to watch the image at the receiving machine, the flash lamp bulb being shorted, before any trouble is taken to get the discs properly synchronised. It will then be noticed that the received image, instead of being stationary, is in motion either in an upward or downward direction. If the image moves in the direction of rotation of the receiving disc the latter is going *too fast*, so that more resistance is needed in the armature circuit of the driving motor.

If, however, the motion of the image is opposite to the motion of the

disc, the latter must be speeded up by cutting out some of the armature resistance. In this manner it will be found quite easy to adjust the armature resistance until the image is perfectly steady, and the synchronising current will then control the speed so that the discs always remain perfectly in step.

Then if the receiving set has been fitted with an adjustment for "phasing," as explained above, this may be used to bring the picture to the centre of the field of view. If no special adjustment has been fitted for the purpose, the entire carcass of the motor-alternator will have to be *slowly and steadily* rotated by hand. To facilitate this adjustment the top of the pedestal supporting the motor-alternator may be shaped like a cradle, so that the cylindrical carcass of the motor can rest in it and be turned freely.

Suggestions for Research.

While the above method of synchronisation with the spiral discs mounted directly on the spindles of the motor-alternators is quite satisfactory, it is really somewhat easier to obtain perfect synchronism with

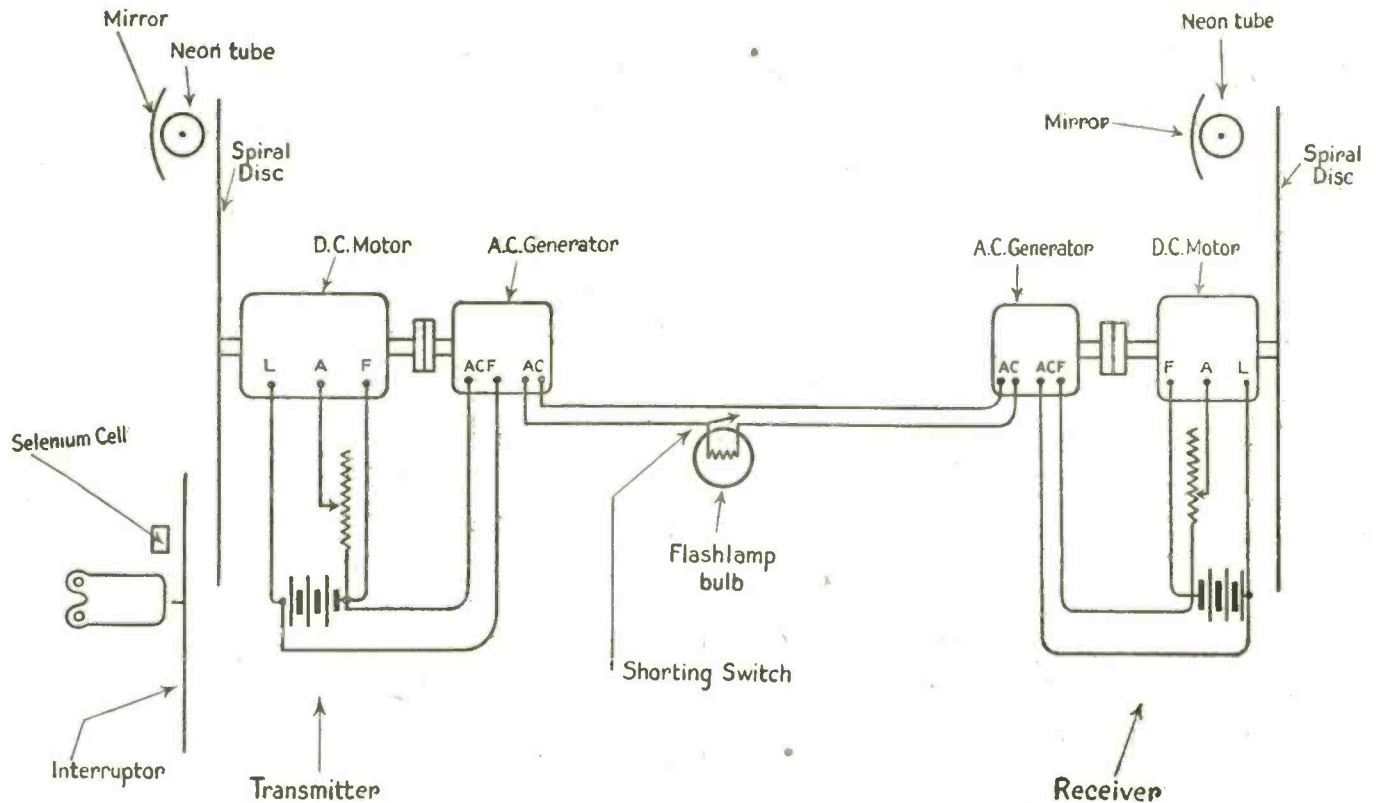
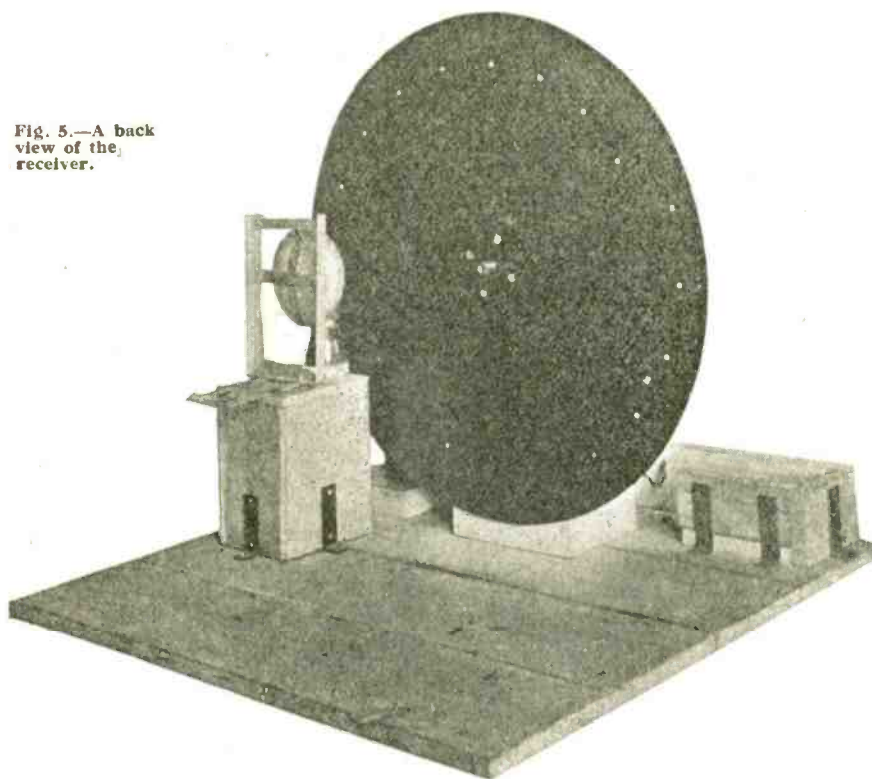

Fig. 1.—Diagrammatic sketch of arrangement of transmitter and receiver. Projector lamp, optical system, and amplifier have been omitted for the sake of clearness.

Fig. 5.—A back view of the receiver.



complete absence of hunting (a peculiar up-and-down swing of the image) by making the alternators run at higher speeds. The present arrangements limit their speed to about 120 r.p.m., because the best all-round speed for the discs is determined by the fact that about 240 images per minute will be found to be the most convenient number to transmit.

Certainly 400 pictures per minute should not be exceeded, or difficulties will be encountered, due to the lag of the selenium cell. Note that two images are transmitted per revolution of the disc, there being two spiral sets of holes in each disc. An obvious refinement is some simple system of gearing made up from "Meccano" parts, of 3 or 4 to 1 ratio.

Again, the amateur may wish to increase the detail in the received image. This may be done by having only one spiral of holes in each disc. For a given width of picture this will double the detail obtainable. Two discs made on this plan will well repay the trouble of making them, as much more complicated shadowgraphs may be transmitted with their aid. It will also be found that the problem of synchronism will be easier of solution, for the discs can be run at twice their former speed.

Announcement

With reference to Condition (2) of the Baird Television Constructor's Sub-Licences granted to readers of this journal by Television Press or by the Television Society, the Editor takes pleasure in announcing that the Baird Television Development Co. has signified its agreement to the apparatus described and illustrated in the foregoing article being included in such licences, and holders thereof may therefore construct and use this apparatus in accordance with the terms of such Sub-Licence.

A review that became a TRIBUTE



"Celestion" Model C.12, the subject of this striking testimony.

The following review of "Celestion" from "POPULAR WIRELESS" is of particular importance to listeners, coming as it does from a foremost radio journal:—

"We found Celestion model C.12 perfectly satisfactory on each of the several sets with which it was tested, ranging from two valves to a multi-valver of the super kind."

"It is some time since we have experienced so much pleasure during a loud-speaker test and we have no hesitation in saying that we consider this 'Celestion' a long way ahead of its class. Those of our readers who have the opportunity should endeavour to hear it in operation. We are sure they will agree with us when we say it is a revelation in what sound design and construction mean to such an instrument."

P.W. 31/3/28.

Write for illustrated folder and also for new Gramophone Pick-up leaflet.

CELESTION

THE VERY SOUL of MUSIC

Write to Dept. T.V.,

THE CELESTION RADIO CO.
Hampton Wick, Kingston-on-Thames

Showrooms: 33/35, Villiers St., W.C.2.

French Agents: Constable & Co., Paris.

METHODS OF SYNCHRONISM IN TELEVISION

By The Editor.

ONE of the greatest problems in connection with television is that of securing and maintaining synchronism between the transmitting and receiving mechanisms.

In photo-telegraphy, as distinct from television, the problem is relatively simple of solution, for the speed of transmission is so very much slower. Also, as will be made clearer later, synchronism in photo-telegraphy need only be carried out in what might be described as a single dimension, as far as the automatic mechanism is concerned; whereas, in television, it must be carried out, in a sense, to two dimensions.

In most systems of photo-telegraphy the problem resolves itself into the rotation at precisely equal speeds of two cylinders, one at the transmitter and one at the receiver. The recording device at the receiver can be set to the correct starting point by hand, and simultaneous starting of the two cylinders can be effected by some form of prearranged signal.

The maintenance of equal speeds of rotation can be accomplished in several ways, which may be roughly divided into two classes, in one of which independent generators of a controlling current of constant frequency are used at both the transmitting and receiving stations. In the other class a constant frequency generated at the transmitter is sent to the receiver and applied there to control the cylinder speed.

Representative of the former class is the system developed by Captain R. H. Ranger, of the Radio Corporation of America, and used in the transmission of photographs, facsimiles, etc., between London and New York and between New York

and Honolulu, by combined wire and wireless transmission.

The circuit arrangements of the Ranger synchronising method are given in Fig. 1. The heart of the device is the electrically operated tuning fork, and this is illustrated in Fig. 2, mounted in an insulated case which is kept heated to a constant temperature by the lamp visible in the lower right-hand corner.

The Ranger System.

The tuning fork is caused to vibrate at a frequency of 70 per second by

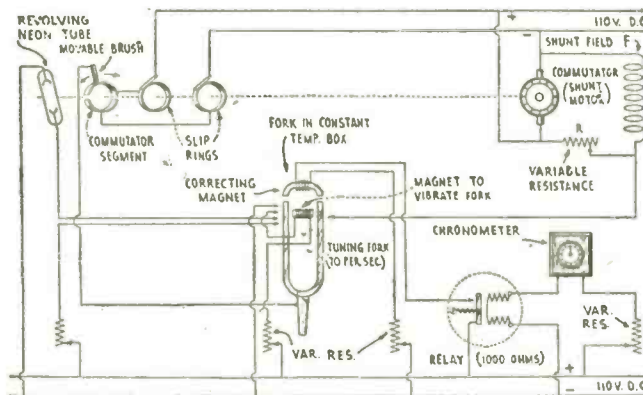

Fig. 1. Diagrammatic representation of the circuit arrangements of the Ranger system of synchronism, used for trans-Atlantic photo-telegraphy.

means of the electro-magnet and interrupter contacts shown, and a chronometer, operating through a relay and the correcting magnet, keeps the frequency of vibration constant.

In the upper right-hand corner of Fig. 1 is the D.C. shunt motor which drives the cylinder, and the vibrating fork keeps its speed of rotation constant in the following manner. If, at a given moment, all the tuning fork and commutator contacts are closed, the variable resistance in series with the field winding of the motor is short-circuited and the speed of the motor is reduced, due to the sudden heavy rush of current through the field winding.

At another moment it may be that the contacts are closed through the tuning fork and auxiliary commutator segments and slip rings at the left-hand end of the motor shaft. In such a case the field winding of the motor will be short-circuited, and due to the greatly weakened field the speed of the motor will increase. This action goes on repeatedly and alternately, so that the average speed of the motor remains constant.

The motor is designed to run at a speed of 2,100 revolutions per minute. In order to check the synchronism

a neon tube is fitted on to the end of the motor shaft, and revolves with it. This tube receives an impulse for each vibration of the fork, i.e., 70 per second or 4,200 per minute. The tube therefore receives two impulses for each revolution of the motor shaft. The result, to the observer, is a stroboscope effect. That is to say, if the motor is revolving in perfect synchronism with the tuning fork, the neon tube appears to be stationary. If the speed is below synchronism, the neon tube

will appear to be turning slowly backwards, like the wheels of a motor-car often appear to be on the cinema-fog screen. If the motor speed is above synchronism, then the neon tube will appear to turn slowly forward.

Exactly similar driving motors and tuning forks are supplied to the transmitting and receiving stations, particular care being taken over the tuning of the forks, so that the transmitting and receiving cylinders are certain to revolve at the same speed, i.e., in synchronism. This method, although eminently satisfactory for photo-telegraphy, would probably not do for television, for

it is rather complicated, and with the greatly increased speed of transmission involved in television the synchronism would scarcely be

periodicity, or frequency, of the alternating current supply, and upon the number of poles present in the rotor or stator, whichever is receiving

The above method gives a more accurate control over the two mechanisms than does the previous method of independent control. In the latter method, absolute constancy of the frequency of both the controlling current generators is a *sine qua non*. In the former method, constancy is not a first requisite, for whatever variations affect the transmitter also affect the receiver in like degree and absolutely in unison. The system can thus be simplified by dispensing with an elaborate constant frequency generator.

In place of it, a small A.C. dynamo can be mechanically coupled to the shaft of the transmitter motor, the generated current being sent to the receiver, there to drive the synchronous motor. It then follows that if the transmitter motor varies in speed, the frequency of the output of the A.C. generator will also vary, which in turn will cause the speed of the receiver synchronous motor and the driving motor coupled to it to vary. The fact that they do vary does not matter, for *they vary in exact unison*, and synchronism is still preserved.

Results of Imperfect Synchronism.

If the transmitting and receiving mechanisms of a photo-telegraphy system are not running in synchronism, distortion of the received image is the result. If, throughout the

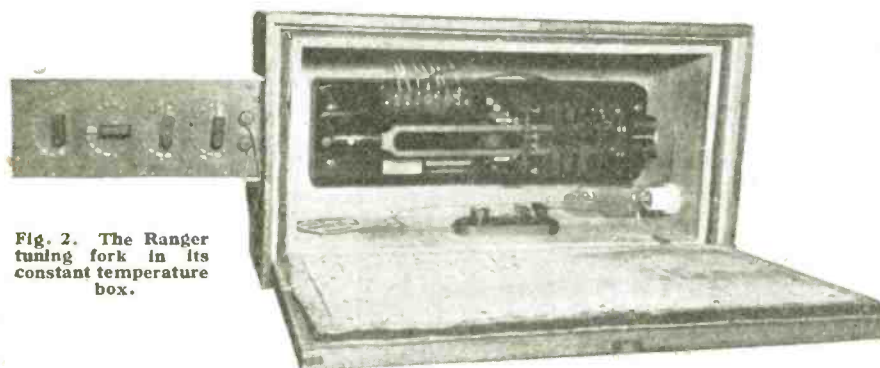

Fig. 2. The Ranger tuning fork in its constant temperature box.

accurate enough. It must be remembered that the Ranger method only keeps the *average* speed of rotation of the motors constant; from instant to instant they vary slightly in speed.

The other synchronising method, in which the synchronism of the receiving mechanism is under the direct control of a constant frequency generator at the transmitter, involves the transmission to the receiver of the constant frequency current, and a control mechanism at the receiver which is capable of being operated at a speed which is dependent solely and absolutely on the frequency of the incoming current impulses.

The Use of Synchronous Motors.

It matters little what form of constant frequency generator is employed at the transmitter. It may be an electrically operated tuning fork, a pendulum, or a valve oscillator controlled by a tuning fork or a quartz crystal; or it may be a small alternating current dynamo coupled to the shaft of the main driving motor of the transmitter.

At the receiver it is usual to cause the incoming constant frequency current to drive a small synchronous motor which is coupled to the shaft of the main receiver driving motor. Synchronous motors consist essentially of an armature, or rotor, supplied with an alternating current; and a stator supplied with direct current. Or the rotor may be supplied with D.C., while the stator takes the A.C. An example of a simple form of synchronous motor is illustrated in Fig. 3.

The speed at which such motors run is entirely dependent upon the

the A.C. It follows, therefore, that if the periodicity of the A.C. supply is absolutely constant, the speed of rotation of the motor is also constant. Furthermore, if such a motor is coupled to another motor which is inclined (if left to itself) to vary in speed slightly, the synchronous motor will keep the second motor running at a constant speed also.

Thus, by generating a constant frequency current at the transmitter, causing part of it to control the speed of rotation of the transmitter motor, and sending part of it over a circuit to the receiver, there to drive a synchronous motor, the receiver motor can be kept running at exactly the same speed as the transmitter motor.

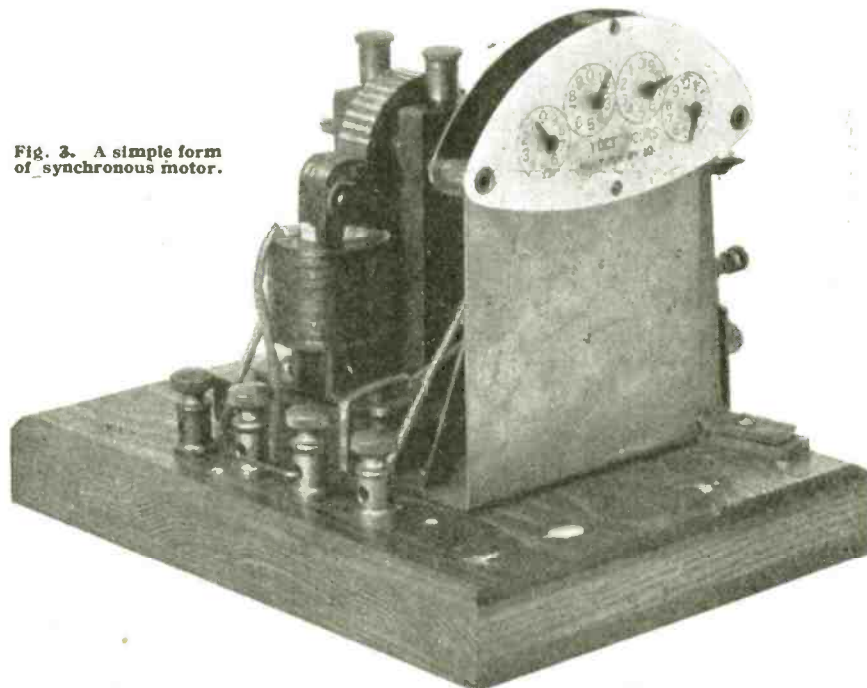
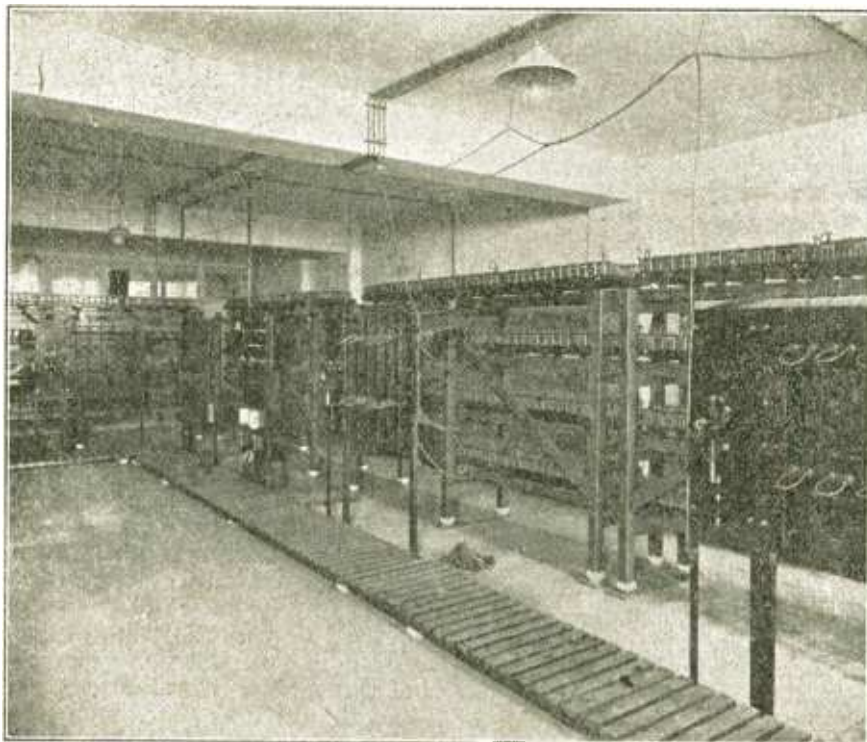

Fig. 3. A simple form of synchronous motor.



A SUPER H.T. BATTERY.

View of the 5,000-volt Hart H.T. battery installed in Baird's laboratory. This is one of the largest high tension batteries in the country. The battery is 40 feet long, arranged round the room in 10-foot tiers, and weighs 6 tons. Charging can be effected by series-parallel switching arrangements, and any voltage below 5,000 can also be obtained on discharge. The capacity of the cells is 13 ampere hours.

transmission, the receiving mechanism is running consistently faster or slower than the transmitter, the received picture, instead of being square in outline, may appear diamond-shaped, and all the details of it will be twisted.

If the receiving mechanism is running at times faster, and at times slower, the distortion will be even worse, and may easily render the picture completely unrecognisable. A similar effect could be produced on a wet photographic negative which has been immersed in warm water to soften the film, by running the finger alternatively up and down it in parallel lines.

In photo-telegraphy, given synchronism between the transmitter and receiver, the two mechanisms can be stopped at the end of the transmission of a picture, and simultaneously restarted for the transmission of the next, thus ensuring that both mechanisms begin at the proper starting point, in step with each other.

In television, however, both mechanisms are running continuously, transmitting and receiving, one after another, sixteen complete pictures

per second. Under these conditions it is possible for both mechanisms to be running at the same speed and still the image may be incorrectly received at the distant receiver.

This difficulty has given rise to a common misunderstanding, prevalent even in technical circles, which, in turn, has caused the problem of synchronism in television to be, to some extent, over-rated.

It has often been stated that a difference of phase of only one per cent. between the transmitter and receiver is sufficient to spoil the definition of the received image. Were such a statement correct, the problem of synchronism would indeed be one of almost insurmountable difficulty.

Fortunately, however, an analysis of the facts shows that if the transmitting and receiving mechanisms are out of phase the image is not blurred, but merely displaced. The definition remains unaffected. The effect is as if the image of a man's face, instead of being visible squarely in the centre of the receiving screen, were displaced to right or left, so that his face appears to be cut off vertically, say, by the nose. On the

other side of the screen the other half of his face will then be visible, also cut off by the nose. In the centre of the screen his right and left ears will be almost touching each other.

In photo-telegraphy a similar effect would be obtained if, on starting the transmitting cylinder at the beginning of a picture, the receiving stylus were set, not at the commencing end of the cylinder, but somewhere in the middle. If, when the recording stylus reached the end of the cylinder it were then lifted and set at the other end of the cylinder, the correct starting point, the result would be that the left half of the face would be on the right-hand side of the picture, and *vice versa*.

This difficulty cannot arise in photo-telegraphy, except through carelessness, for the correct starting point is arranged first by hand before starting up. In television, with continuously-running mechanisms handling sixteen complete pictures per second, it is not possible to arrange the starting point correctly by hand, and some electrical or mechanical means of doing the job must be found. This is what was meant when it was stated that, in television, synchronism must be carried out, in a sense, to two dimensions.

Isochronism and Synchronism.

The distortion, or blurring, of a television image is caused only by different speeds prevailing at the transmitter and receiver; that is to say, by lack of *isochronism*. Two mechanisms may be in isochronism and yet not be in synchronism. As some of our readers may not be familiar with the distinction, it may not be out of place to define it here.

When two machines are said to be running in isochronism, what is meant is that they are running at the same speed, but are out of step, just as two men's feet may be out of step although both are moving at the same speed and the feet of both strike the ground at the same instant. A similar case is that of two clocks which are both keeping perfect time, although the hands of one might point to 2.30 and the hands of the other to 3 o'clock. Isochronism has been achieved in both cases, but for synchronism to be achieved the two men would have to be what the army calls "in step," and the hands of both clocks would have to indicate exactly the same hour.

When the first efforts were made to achieve television, attempts were made to obtain isochronism by means of the methods used in photo-telegraphy, briefly referred to above. Such methods, however, do not lend themselves to television, for, as already stated, they are either too complicated or insufficiently accurate, or both.

By using synchronous motors, however, perfect isochronism can readily be obtained, and the mechanical and electrical arrangements involved are not nearly so complicated. It was with the aid of such motors that the first successful results in television were achieved by Mr. J. L. Baird.

At first glance it might be supposed that isochronism between two television mechanisms could be obtained by using two exactly similar motors controlled by rheostats and run at exactly the same speed, as indicated by some form of speedometer. This cannot be done, however, for ordinary electric motors continually vary slightly in speed, due to small variations in the supply current and other reasons. These variations occur too rapidly to be corrected by a hand-controlled rheostat, even if the speedometer revealed them. This habit of variation is known as "hunting," and before television can successfully be achieved the hunting propensities of at least one of the machines must be brought under exact control.

Synchronising, or Phasing.

The main driving motor at the transmitter has this usual tendency to hunt; but if the system of synchronism employed involves the use of an A.C. generator coupled to its shaft to produce the isochronism impulses, the driving motor may be allowed to hunt unchecked, for the periodicity of the generated A.C. varies in exact accordance with its speed wanderings.

On the other hand, the main driving motor at the receiver is not allowed to hunt independently. Its speed is under the cast-iron control of the synchronous motor coupled to it; and as the speed of the latter varies precisely in sympathy with the periodicity changes of the distant A.C. generator, it follows that the main receiver motor must at all times be revolving at exactly the same speed as the main transmitter motor. The fact that they both hunt slightly

does not matter, for they hunt in unison. Therefore, isochronism is achieved.

There remains now the question of synchronism. That is to say, although we now have the two machines running at exactly the same speed, we have, as yet, no means for adjusting the mechanisms so that they run *in phase* with each other.

As stated earlier on, a difference of phase does not cause blurring of the image or loss of definition. It merely causes a shift of the image as a whole, and this image shift is very simply rectified by the expedient of rotating the receiver driving mechanism as a whole about its spindle until the picture comes into view in its proper place.

This rotating action is very similar in principle to the method of adjusting the gap of a synchronous spark wireless transmitter. In the latter case, since the revolving electrodes are coupled to the shaft of the A.C. generator, the two must at all times be in isochronism. The spark, however, may easily be out of phase, as indicated by an apparent violent oscillation back and forth of the revolving electrodes, as viewed end on while the discharge is taking place. To bring the spark into phase, the fixed electrodes are simply rotated round the circumference of the moving disc until synchronism is indicated by the revolving electrodes appearing to stand still.

The phasing of a television image may be compared to the action performed by a cinematograph projector operator when the picture appears on the screen with people's feet at the top of the screen and their heads at the bottom, with a dividing line across the middle. All that is required is a simple adjustment to "frame" the picture properly.

Practical Details.

In Fig. 4 a view is given of a television receiver driving mechanism. At the extreme right-hand end of the shaft is the scanning disc. Further to the left, within the carcass, is the main driving motor, which may be supplied with either D.C. or A.C.,

whichever is available. To the left of that, and still within the carcass, is the synchronous motor which controls the speed of rotation of the main motor, giving isochronism.

The carcass of these motors is mounted on bearings, so that it can be rotated bodily by means of a handle operating through a worm gear, as shown in the diagram.

It will be seen that this mechanism has the merit of extreme simplicity and it seems to work extremely well in practice, for it is essentially the method used not only by Baird in this country, but also by the American Telephone and Telegraph Co. in their demonstration last year between Washington and New York.

Mr. Baird's British Patent No. 236978, of March 17th, 1924, describes this method of rotating the mechanism to obtain synchronism.

There still remains the question of the transmission to the receiver of the A.C. isochronising current generated at the transmitter. Over short distances this can be done by means of a simple wire connection.

It is, of course, impossible at the present time to transmit power by wireless, or over a telephone line. Therefore, some means must be provided whereby the A.C. can be caused to influence the receiver. This is done by causing the A.C. to modulate the carrier current, in the case of wire communication between the two distant points, or the carrier wave, in the case of radio communication.

This modulation, of course,
(Continued on page 36.)

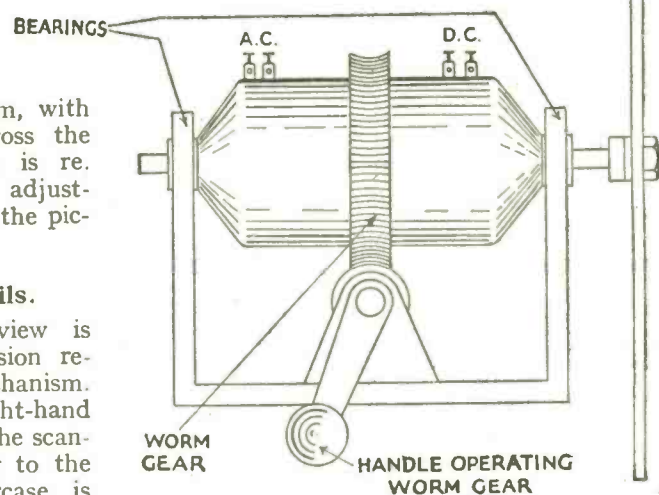

Fig. 4.

Showing the operation of the worm gear for rotating the carcass of the receiver driving motor and its associated synchronous motor.

The Protection of Television Inventions

By Patent Expert

THE publicity now being given to discoveries in connection with the science of television will no doubt cause many amateurs to become sufficiently interested in the art to encourage them to experiment themselves; and the present state of television is such that we may expect quite a number of new developments and discoveries to be made in connection therewith in the near future.

Scope for Research.

In television there is at the present time probably more scope for research work and improvement than in any other science. It is true that during the past few years great strides have been made, but there still remains a lot to be discovered and it is well within the realms of possibility that keen amateurs experimenting in this direction may discover some new feature, which may assist the perfecting of television, and which, incidentally, if protected and handled in the right way, may benefit the inventor financially.

It is the purpose of this article to advise amateurs who may discover or invent something new during their experimental work, how to obtain protection for their inventions in the first instance, without which little can be done to ensure that they will receive the reward to which they are entitled.

"Provisional Protection."

The English Patent Laws have been designed to protect inventors by allowing them at a comparatively small cost to obtain protection for their inventions.

It is possible to obtain what is known as a "Provisional Protection" for an invention. This gives the applicant a nine months' option (which may be extended to ten months on payment of a fee of £2), in which to obtain a full patent in England for his invention. Provisional protection also gives him similar rights over a period of twelve

months in many foreign countries which are parties to an agreement known as the International Patent Convention.

The nine months' option in England provides a period during which the inventor may develop his invention and prove its value, and if the results obtained during this period appear to be promising he may then apply for a full patent; or, on the other hand, if further experiments show that the earlier discoveries are not worth proceeding with, the application may be allowed to become void, thereby avoiding any further expense.

Where to Apply.

In order to secure provisional protection it is necessary to file at the Patent Office, 25, Southampton Buildings, London, W.C. 2, a provisional specification in duplicate, accompanied by a Patents Form No. 1 (which is an application form for a patent) and if necessary suitable drawings in duplicate illustrating the invention. The Patents Form No. 1 must be stamped with a £1 stamp. The form in question can be obtained free from room 28 of the Patent Office, and after completion it can be stamped at the same room on payment of £1.

If it is not convenient to attend the Patent Office personally a stamped form can be obtained at any post office by giving a few days' notice.

In preparing the provisional specification care should be taken to see that it describes the invention in its broadest aspect; do not be content to tie yourself down to too much detail. It would be disastrous to find later, when a complete patent is applied for, that, had you more widely described your invention, claims could have been obtained which would have given you a much broader protection than will be allowed if the invention is described too specifically.

On the other hand, there is something to be said for giving a detailed description of at least one suitable

way of carrying out the invention. In the event of citations being made by the Patent Office Examiner later when a complete patent is applied for it may be necessary to amend the specification and restrict the invention in view of prior disclosures falling within the ambit of your broad claims. In such an event it is useful to be able to rely on some constructional details possibly to differentiate the invention from earlier ones.

Therefore the ideal specification, in my opinion, is one that commences by broadly describing the nature of the invention. This should be followed by an example of how it is proposed to carry out the invention, and if needs be reference may be made to drawings accompanying the description. The document should be typewritten on foolscap paper, leaving a margin on the left-hand side of the paper, and only one side of each page may be used.

Preparing Specification and Drawings.

The original drawings should be made on good quality cartridge paper of the same size as the specification paper. They should be prepared in black drawing ink and the duplicate, or "true copy" as it is called, should preferably be made on tracing linen. The reference letters used to designate different parts of the invention and the leading lines thereto should be in ink on the original and in pencil on the "true copy" drawing.

In conclusion I must point out that it is impossible in so limited a space to go into many details that should be observed when applying for provisional protection, but these few remarks should be sufficient to guide the amateur and inventor in safeguarding his interests by seeking patent protection for his inventions.

Before the expiration of the nine months' provisional protection, or with maximum extension of ten months, it is necessary to apply for a complete patent or abandon the application.

Exide for High Tension

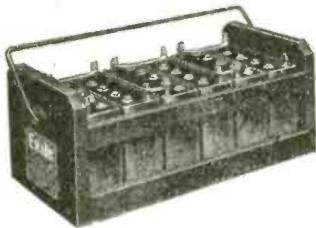

TYPE WH 60-volt.
In Crate with Detachable Wire Carrying Handle.

The Exide WH is the best H.T. Battery ever produced, and discriminating wireless experts throughout the world are proving the truth of this assertion.

The 5,000 milli-ampere hours capacity makes it particularly suitable for supplying the heavy H.T. current demanded by Television, whilst every feature of the battery has been designed to eliminate trouble and secure long life.

The very reasonable price—9d. per volt for the 10 volt unit—has been made possible by the reduction in manufacturing costs, due to the ever increasing output, the advantage of which, in accordance with the makers' fixed policy, is passed on to the user.



TYPE WH 10-volt
Capacity 5,000 milli-amp. hrs.

INSTALL A 5,000 MILLI-AMP. HRS. WH BATTERY

Obtainable from any Exide Service Agent or your local dealer.

	Dimensions.	Weight.	PRICE
WH 10-Volt unit	2 ⁷ / ₁₆ in. × 7 in. × 5 ¹ / ₂ in. high	6 ¹ / ₂ lbs.	7 6
WH 40-Volt unit	6 ¹ / ₈ in. × 15 ¹ / ₂ in. × 6 ¹ / ₂ in. „	27 ¹ / ₂ „	£1 17 6
WH 60-Volt <small>Complete in crate as illustrated</small>	8 ¹ / ₂ in. × 16 ¹ / ₂ in. × 6 ¹ / ₂ in. „	41 „	£2 14 0

Advertisement of The Chloride Electrical Storage Co. Ltd., Clifton Junction, Manchester.

TELEVISION SOCIETY. MEMBERSHIP APPLICATION FORM.

May, 1928.

Please send me particulars and conditions of membership of the Television Society.

Name

Address

I desire to enrol as (Fellow or Associate) and submit qualifications:—

Academic Qualifications or

Scientific Pursuits

THE SECRETARY OF THE TELEVISION SOCIETY,
[Stamp enclosed.] 200, High Holborn, W.C.2.

ORDER FORM.

To TELEVISION PRESS, LTD.,
26, Charing Cross Road, London, W.C.2.

I enclose herewith ^{Postal Order} ^{Money Order} _{Cheque} for 7/6 in respect of one year's subscription to "Television," commencing with the issue.

Name

Address

Postal and Money Orders should be crossed & Co. and Cheques should be made payable to Television Press, Ltd.

Announcement

Readers are reminded that the construction of any television apparatus, as described in the issues of this Magazine, constitutes an infringement of the Baird patents and renders the infringer liable to legal proceedings unless he is the possessor of the constructor's sub-licence that may be obtained in accordance with the offer contained on page 37 of the April issue.



APPLICATION FORM.

In accordance with the offer contained on page 37 of the issue of "Television" for April, 1928,

I (Full Name)
of (Full Postal Address)
..... hereby apply
(Occupation)

PLEASE WRITE IN BLOCK CAPITALS.

to Television Press, Limited, for the issue to me of a CONSTRUCTOR'S SUB-LICENCE and agree to be bound by the provisions of such sub-licence.

A STAMPED ADDRESSED ENVELOPE MUST BE ENCLOSED WITH THE ABOVE APPLICATION.



"JEANIE," says I, portentously, "I have decided."

"Ay," says Jeanie, darning ma winter pants.

"I mean," I adds, explanatory, "I've made up ma mind."

"Ay," says she, still darning ma winter pants.

Och, it's gey queer how wumman's never filled wi' curiosity when ye're wanting her to be.

"Jeanie," says I, real sharp.

"Eh!" says she, looking up wi' a start.

"I've decided to be a *televisionary*."

"Och, Jock, ye're daft. Ye ken fine they faddy things jist upset yer stomach."

"Wumman," says I, dramatic, "televisionary has naething to dae wi' the stomach. On the contrary. Ay. Och, it's a fine idea, it is that. But mebbe, Jeanie, I'd better explain it a bit so ye'll see for yersel what a fine idea it is. Television, Jeanie, is seeing things that arena there."

"I ken," intersperses Jeanie, "like when Jimmie Blair saw the pink rats wi' green tails."

Jock Explains Television.

"Yer intelligence," says I, keeping polite wi' difficulty, "would upset the digestion o' a sheep. However, I'll put it simpler. It's a bittie like wireless. At one end ye've got a sort o' camera affair which takes pictures and at the ither end ye've got a receiving set wi' a bit screen where ye can see the pictures jist as if ye were sitting aside o' the camera. Only they're no' exactly the ends o' onything for there's naething atween them but only the etherial ether. And it's all been invented by a braw Scots laddie. Is that no' wonderful?"

"Ay," says Jeanie, "it sounds no' bad. But where dae you come in?"

"That's the fine idea," says I, inflating ma chest wi' pride. "I'm going to help that Scots laddie in the maist important bit o' his work."

"You?" says Jeanie, looking at me queer. "Ha, ha! Ye *are* a comic, Jock. Ma conscience, ye are."

"I am not," says I, asperiously. "I'm perfectly serious. Inventors are all right, but they've got to have what are called visionaries, Jeanie. To give ye an example,



"Hens . . . are aye . . . laying eggs on the top o' haystacks."

it was nae use at all for an inventor to find out how to bend a bit wire wi' curly bits in't if somebody hadna seen it would be real useful as a hair-pin. Na, dinna interrupt. Now, if this Scots laddie's allowed to gang on by himsel he'll be inventing all sorts o' television that's mebbe nae use at all. Sae I'm going to work out how his invention'll be real helpful to folks and then, ye see, Jeanie, he'll ken the lines to work along. It'll be fine, too, keeping the whole idea, holus bolus, as ye might say, in Scotland."

"Imphm," says Jeanie, "imphm."

"I suppose," says I, "the super-

lative magnificence o' the idea's sort o' taken yer breath awa'."

"Na," says she, shaking her heid, "I was jist wondering if it wouldna have been better if ye'd kept on wi' yer epic poem on the bumble bee."

"Och," says I, "I can finish that ony time; but this television business's got to be done the noo. As a matter o' fack, I've got one part o' it all worked out already which I've wrote down in ma book under the title '*Agricultural Television*.' That means television for the farmer, ye ken. It's the classic way o' putting it. It deals wi' the subjeck maist exclusively, Jeanie, and though mebbe ye'll no' grasp it all, I'll read ye bits here and there."

"Agricultural Television."

Here I got ma book off ma literary bureau, which is also, alas, the kitchen dresser, imbibed a large quantity o' water, cleared ma throat impressively and commenced.

"Hens, being o' the feminine gender are aye daeing things ye dinna expeck them to dae, like laying eggs on the top o' haystacks where ye dinna look for them and they gang rotten. Wi' television the farmer could actually see the feckless bird laying its eggs on the top o' the haystack. Wat dae ye think o' that?"

"Weel, Jock," says she, "even if ye did see the hen performing her natural functions in a unnatural position I dinna see it would help ye. For ye couldna get to the top o' the haystack in ony case."

"There is that," I admits, graciously, "but ye see, when the farmer did get the egg eventually he would ken it had been there for months and no' be for selling it as '*New Laid*' for fear o' lossing his reputation. Which would be a great

(Continued on page 44.)

One or two more points on the Television Amplifier

By JAMES B. ELMORE

MANY readers have sent letters asking for details of the best high-tension supply for the television amplifier described in the April issue of this journal. They tell us that, after purchasing the recommended valves the opportunity was taken to make a perusal of the literature which the valve makers usually enclose in each carton. It was then learned that each D.E.5 or P.M.6 consumed high-tension at the rate of 12 m.a., each P.M.256 or D.E.5A, and that the two L.S.5A valves or the two D.F.7 valves were rated to consume 60 m.a. each. Thus the total drain on the high-tension supply for the full number of valves when correctly biassed appears to be something in the neighbourhood of 100 m.a., which is much higher than the normal run of radio sets.

There is no occasion for the amateur to become alarmed at this apparently extravagant figure, however, for it represents only the maximum current which will be drawn if all the valves are working to capacity. In actual practice the current drawn from the batteries when the television amplifier is in operation does not exceed 30 or 40 m.a.

Good Dry Batteries Adequate.

Where it is desired to keep down the initial cost of the apparatus builders of the simple television apparatus described will, of course, draw their high-tension from good dry batteries. Such persons will be interested to know that the early experiments in television were made with this type of battery and that it proved very successful. So far as the simple television is concerned it is also to be recorded that at the recent demonstrations of this apparatus at Messrs. Selfridges store in Oxford Street, Messrs. Shoobreds of Tottenham Court Road, and at the Engineers Club upon the occasion of a meeting of the Television Society, dry batteries

were used to supply the high-tension current.

Naturally, any reader proposing to make use of this source of current supply would assure himself that the particular make procured for the purpose was of the high capacity type, and in addition, was one of the quick-selling brands, as dry batteries sometimes drop in voltage during storage. In these circumstances a shortened life might also result.

Notes on H.T. Accumulators.

By virtue of the comparatively high current consumption of the amplifier some readers are turning their attention to high-tension accumulators. Here again, it must be remembered that high capacity types are just as necessary as in the case of dry batteries. Manufacturers of this product should be asked which of their various types is the most suitable for this amplifier, when we feel certain that complete satisfaction will ensue.

With this type of battery it is wise to keep a watchful eye upon its condition, as the trouble usually experienced with the high-tension accumulator is generally due to excessive discharge. Therefore, arrange for the periodical recharges

as frequently as the battery requires them. Here again the manufacturer of the battery will be able to advise you.

One further remark on this question of high-tension supply.

The Use of Mains Units.

Those of our readers who are fortunate to have electric mains in the house will most probably prefer to draw the required high-tension from the house supply. If power lines are laid so much the better. Few, if any, words will be required to remind such readers that, just as in the two foregoing instances, it is important to bear in mind the current which is needed for this amplifier. Should it be the intention to invest in apparatus of this type the recommendation of the particular manufacturer is certain to be of considerable assistance in the choice of a suitable type.

Lastly there is on the market also certain apparatus which will supply both filament and anode current for this and similar amplifiers. The manufacturers would no doubt be pleased to recommend a suitable model for the particular current demands in question.

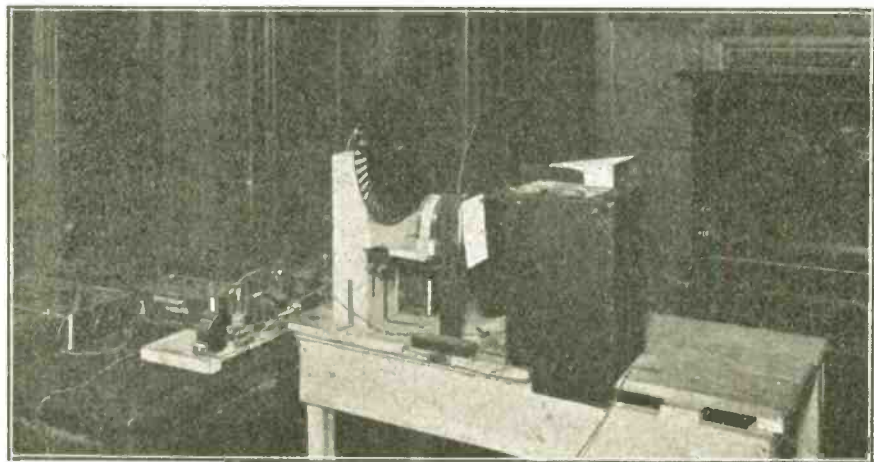

The simple Television and Amplifier photographed at the Television Society demonstration. The two batteries at the extreme left supplied the H.T. The third battery, immediately behind the amplifier, supplied grid bias.

Television Problems and Their Solution

By C. B. MAXWELL

INVESTIGATORS in the field of television are faced with four fundamental problems which must be satisfactorily solved before any results can be achieved. These four problems may be stated as follows:—

- (1) To obtain a sufficiently powerful reaction from the light-sensitive device.
- (2) To obtain an image-exploring device capable of dividing up the picture into a sufficient number of sections, or picture elements.
- (3) To obtain and maintain synchronism between the transmitting and receiving mechanisms.
- (4) To obtain a light source of sufficient brilliancy and sufficiently rapid in action to reproduce the picture on the receiving screen.

The methods which have been used, and the apparatus which has been devised in the course of many efforts to solve these problems, are numerous; but the only successful methods disclosed to date are those in which rotating mechanisms have been employed.

To deal with the first problem, this has been solved by traversing the image with a light spot of intense brilliancy, according to the method described by the Technical Editor in the first and second issues of this magazine. This method was originally devised and used by Baird in 1926.

Another method is possible, however, which requires, as a first consideration, that the sensitivity and efficiency of the light-sensitive device be increased until it becomes capable of responding to the exceedingly small and exceedingly rapid light impulses that fall upon it as it is traversed by the image. This has the great advantage that it is not necessary to use the very special means of lighting indicated by the travelling light spot.

The travelling light spot, while a very efficient and very simple means of overcoming the problem, has of necessity some rigid limitations. The object to be transmitted must be sufficiently small to come within the limits of the moving spot. Under such circumstances it is difficult to conceive how any extensive or outdoor scene could be transmitted by this means.

However, when the picture to be transmitted is of a limited character (such as, for example, the head and shoulder view of a person, or even a full figure, or similar scenes) the light spot is quite suitable, and it has been employed successfully not only by Baird in this country, but latterly by the American Telephone and Telegraph Co. and the General Electric Co. in America. These two latter companies are the only people outside these islands who have successfully

demonstrated television, and it is significant that in order to achieve success they found it necessary to use the light spot and a rotating mechanism to cause the light spot to traverse the object being transmitted.

It is noteworthy, however, that in his later experiments Baird has been able to dispense with this method of illumination, and in several of his demonstrations has transmitted by ordinary flood lighting. This has become possible as the result of improvements which he has been able to effect in the sensitivity and efficiency of his apparatus.

The importance of these transmissions by ordinary flood lighting lies in the fact that they indicate the possibility of dispensing with the means described of traversing the image by an intensely brilliant light spot. At the present juncture,

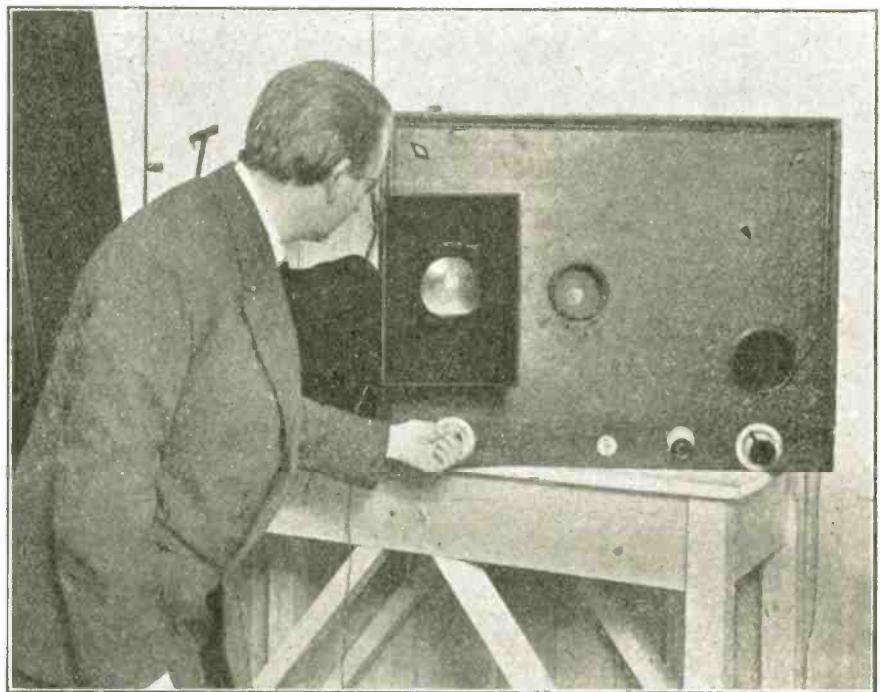

A new photograph of Mr. J. L. Baird "looking in" on the screen of the identical television which was used in the recent trans-Atlantic and mid-Atlantic experiments.

however, when only restricted scenes can be transmitted it is questionable whether there is any advantage in using flood lighting instead of light spot illumination. In fact, owing to the simplicity of the mechanism required in the light spot system, it is probable that for restricted scenes this is the more advantageous method; although as television develops, and it becomes necessary to transmit extensive scenes, the light spot system will inevitably be superseded by the flood light method.

Image-Exploring Mechanisms.

The next problem which has to be faced is that of providing a mechanism whereby the scene may be divided optically into an enormous number of little areas, and then cause these little areas to fall in succession upon the light-sensitive cell.

A great number of mechanisms have been devised or suggested for the achievement of these ends, the simplest being a system of rotating perforated shutters, the perforations being arranged in spiral or in staggered formation. This spiral disc has been known to the art for a great number of years, being in fact first disclosed in 1884. Other methods involve the use of rotating lenses, prisms and mirrors, oscillating mirrors, oscillating lenses, and combinations of these devices.

Apparatus which depends for its functioning upon the rapid movement of mechanical parts is faced with the

difficulty that a limit of speed is soon reached beyond which mechanical considerations prevent a further speeding up of the mechanism, which in turn prevents the reproduction of a finer-grained picture. Therefore,

the most extensive research work upon cathode ray television has been proceeding for many years.

It is noteworthy that the use of the cathode ray as a means of achieving television was first disclosed in print

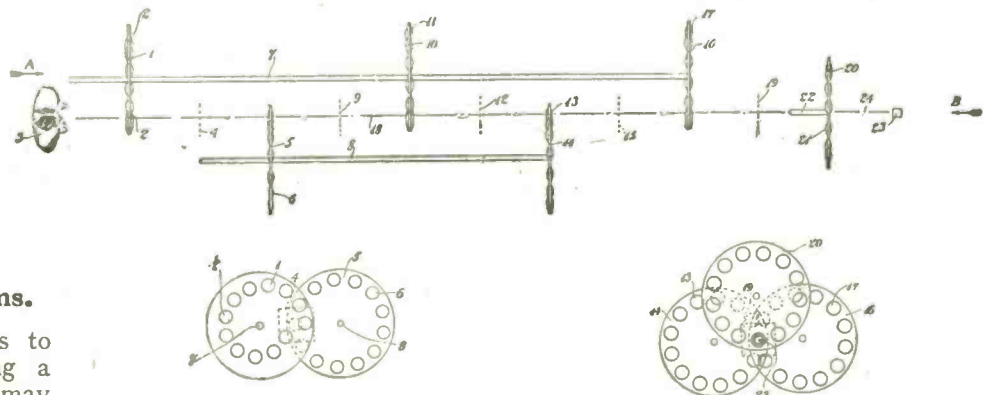

Diagrammatic representation of Baird's Optical Lever.

although such mechanical devices are perfectly satisfactory up to the limit of a picture divided into about 90 strips, when we consider a further refining of the image mechanical devices fail, and we are compelled to seek for some device in which there is no inertia.

Before proceeding further, however, mention must be made of a patent recently published in which Baird discloses optical means of multiplying the speed of traversal of the image. This is done, briefly, by causing one exploring device to explore the moving image cast by another preceding it, so that the motion of the several devices is additive, and by increasing the number of exploring mechanisms any desired speed of traversal and any desired fineness of grain of the image may be obtained by purely mechanical means, and without encountering any mechanical limitations whatsoever.

by Mr. A. A. Campbell Swinton in a paper read before the Wireless Society of London in 1913.

However, in spite of the sustained efforts which have been made, no success has so far been achieved, with the exception of the transmission of very crude shadows, such as the shadow of a moving finger. This failure to achieve success is probably due to the low intrinsic brilliancy of the cathode ray spot (as made visible on a fluorescent screen), and to the difficulty of handling the cathode ray in a definitely modulated fashion.

Synchronism

The third problem is that of synchronism, and the first and simplest successful solution entailed the use of synchronous motors controlled by an alternating current transmitted from a generator coupled to the transmitting apparatus. This is the method which was used by the American Telephone and Telegraph Co., but once again it is necessary to point out that this method, like the light spot system, was first employed successfully in this country when Baird publicly showed the transmission of outlines between two completely separate machines in 1925.

Other methods of synchronism (and methods which do not involve the use of a separate synchronising signal) are indicated by the use of oscillating mechanical and electrical circuits. These provide means of keeping synchronous motors controlled by their oscillations in exact step with the distant transmitting mechanism.

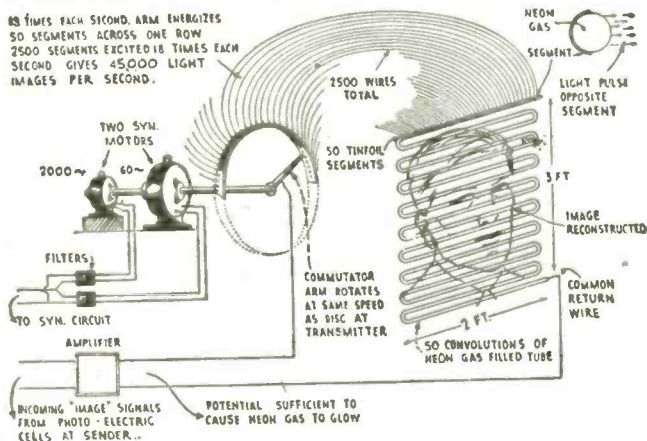

The large exhibition screen, built up of a continuous length of glass tubing, along the rear walls of which are cemented 2,500 tin-foil segments. The tube is filled with neon gas; light spots appear opposite each segment when electrically energized.

Sketch of an arrangement, based on one of Baird's patents, whereby a large screen consisting of an extended form of neon tube is illuminated by means of a commutator arrangement revolving in synchronism with the transmitter.

The Light Source.

The fourth problem is that of obtaining a suitable source of light at the receiving station, where it is necessary to arrange for a point of light to traverse the screen and vary in intensity exactly in accordance with the light and shade of the picture which is to be reproduced.

As the traversing point of light is extremely minute in area, and moves with extreme rapidity, it is obvious that the light source must be instantaneous in its response to impulses coming from the transmitting station; and as the single spot of light must illuminate the entire screen it is also obvious that the light source must have a sufficient intrinsic brilliance.

A light source instantaneous in action is available in the form of the glow discharge tube, such, for example, as the familiar neon tube used for advertising display purposes; and neon tubes are used at the present moment in the only systems of television which have so far proved successful.

Where a much larger screen is desired for the purpose of general exhibition to a large audience, a light source such as the neon tube is obviously insufficient in brilliance for the purpose, but another method is possible.

This method, which is described in one of Baird's patents, makes use of a large number of light sources which are arranged to form a screen. These light sources are then illuminated in succession by a commutator revolving in synchronism with the exploring device at the transmitter. By this means a receiving screen of any desired size and any desired degree of brilliancy may be produced, but the apparatus is necessarily very complex.

In spite of the complexity, however, such a large screen, together with its associated apparatus, was actually constructed and put into operation by the American Telephone and Telegraph Co. This company, of course, has available gigantic resources both in men and in money, and in spite of the successful application of this system it is questionable if such a complex device will ever come into general use. It may possibly come into use in theatres, where expense is a secondary consideration, but it is scarcely conceivable that it will ever be applied successfully to home television.

It is to be hoped that this brief and

somewhat general survey of the four outstanding problems of television, and the methods which have so far proved successful, will give readers a clearer understanding of them and point the directions in which experimenters may usefully apply themselves in their search for simpler and more efficient means of achieving the desired result.

Power of Optical Instruments

(concluded from page 17).

we should reduce the diameters of the two star discs by one-half, i.e. to the size shown in dotted circles in Fig. 4, corresponding to a resolving power of one-sixteenth of a second—by doubling the diameter of the object-glass we should have doubled its resolving power.

It is interesting to know that Airy's theoretically deduced equation for the resolving power of a telescope given above has been abundantly verified in practice. The English astronomer, Dawes, gave as the result of his many years' experience on double stars the equation:

$$\alpha = \frac{4.56''}{D} \dots (2)$$

where α is the resolving power of the telescope in seconds of arc, and D the diameter of the object-glass in inches.

Now the resolving power of the eye is about 68 seconds, as we have shown above (68 seconds of arc equal the angle $1/3000$ in circular measure), so that $68/\alpha$ gives the minimum magnification required to bring out the full resolving power of any object-glass. This works out at fifteen times per inch of aperture.

Any magnification beyond this is optically unnecessary. Thus the full power of the Yerkes object-glass can be got with a magnification of not more than 600, although much higher powers are often used for convenience. The limit to the necessary magnifying power for the most powerful microscopes is of the same order of magnitude.

TELEVISAGES.

The youthful emigrant used once to wear
His fair fiancée's photo. next his heart:
She posted him a fresh one every year
Throughout the time they had to be
apart.
But now her features, in the modern way,
She televises to him every day!

LESLIE M. OYLER.

Methods of Synchronism in Television (concluded from page 29).

takes the form of a continuous note of audible frequency, corresponding to the periodicity of the generator output. The American Telephone and Telegraph Co., when they gave their demonstration, used a separate channel for the synchronising frequency, but Baird has used the same channel which conveys the television impulses, separating the two sets of impulses at the receiver by means of filters.

Whichever method of transmission is employed, at the receiving station the synchronising note, after amplification by means of a valve amplifier, is fed to the synchronous motor.

Elsewhere in this issue an article by our Technical Staff makes clear the principles of synchronising two machines (connected by wire) which are not so widely separated that amplification of the synchronising impulses becomes necessary.

The Synchronising Frequency.

As regards the frequency of the alternating current used for synchronising, Baird used, in the course of his original experiments, a frequency of 60 cycles; but the higher the frequency used, within limits, the more accurate is the degree of control. During their Washington-New York demonstrations, the American Telephone & Telegraph Co. used a synchronising frequency of 2,000, which is, perhaps, unnecessarily high, and renders essential the use of a separate channel to carry the synchronising impulses.

In this article we have concentrated on the synchronous motor method of obtaining synchronism, because it is the only method which, so far, has been publicly described by successful demonstrators of television as being suitable for television purposes. In the future, no doubt, other successful methods will be described, which will not only be effective, but also do away with the necessity for the use of a separate channel of communication.

There is an unlimited field of research here for interested experimenters.

To ensure
receiving your copy of
"Television" place a regular
order with your
newsagent



The Television Society

REPORT ON FIRST FORMAL MEETING.

THE first formal meeting of the Television Society was held on April 3rd at the Engineers' Club, Coventry Street, W.C.2.

Dr. Clarence Tierney, D.Sc., F.R.M.S., who presided, referred in his opening speech to the purpose for which the Society was founded—i.e., to afford a common meeting ground for all who are interested in the electrical transmission and reception of light waves, whether they be amateur or professional workers in the field.

We owed, he said, a great deal to the amateur worker. One instance only, familiar to them all, needed to be quoted to prove the truth of that—the field of radio communication. The amateur had done much to develop wireless telegraphy in the early days. Latterly he was responsible for the initial experiments which led to the inception of broadcasting; and because, after the establishment of broadcasting, he was deprived of the wave-band upon which he was accustomed to conduct his experiments, and forced down to a ridiculously low wave-length, the amateur made the best of things and made the discovery, hitherto unknown, that very short waves make possible world-wide communication by means of very low power.

Value of the Amateur.

The amateur, who took up a subject for the love of it rather than for the purpose of making a living, had a persistence and desire to accomplish which was most valuable.

In television a good deal had already been accomplished; nevertheless there was still an enormous amount of work to be done, and the amateur could assist materially. Owing to the facilities at his disposal, and the amount of time which he could afford to devote to the subject, the amateur could carry out experi-

mental tests in order to ascertain the value of the work which has already been done by serious workers, and determine for themselves whether the methods used, and the results already obtained, were good or bad.

Television Proved Possible.

Abstract science made no appeal to the amateur or to the layman. What interested them was the application of science, and it was in that sphere that he thought the amateur's greatest use lay, and there, too, was the function of the Television Society.

It was perfectly clear in these days that they were following no Will o' the Wisp. Television was within the region of practical politics. It was possible electrically to transmit and reproduce light waves over considerable distances, and it had been done for some time past by several workers.

It might be asked why, when there was so much talk of television, the actual apparatus for its accomplishment was not on the market. The reason was that in its original form every scientific achievement required the use of complex apparatus which was very difficult for any but the expert to operate.

But having achieved the desired object and gained the desired knowledge, it was quite possible to evolve a piece of apparatus which would accomplish exactly the same thing and yet be simple to operate.

Even so, the amateur was quite at liberty to test for himself and develop along different lines to achieve a definite object, and that object, as far as the Society was concerned, was the electrical transmission and reception of light waves.

Before the meeting ended they were to witness a demonstration of a simple apparatus for the transmission and reception of shadowgraphs. This machine would give a very compre-

hensive idea of the possibilities that lay in the development of that type of apparatus.

Following Dr. Tierney's opening remarks the next item on the agenda was the Articles of Memorandum and Association. In explaining these matters, Mr. T. W. Bartlett said the Society, as they were aware, had been formed with the idea of exploring every possible avenue of knowledge relating to the new science of television.

In the case of any new society it was well that it should be started off on a proper footing with a set of rules to which any member could refer, and which, as far as possible, would meet all reasonable contingencies.

When a new society was formed there were two courses open for it to adopt. It could either be founded by charter or by incorporation. Foundation by charter was a long and costly business, and in the present instance incorporation had been decided upon as the more suitable way. The Society would be registered under the Companies Acts, and by so doing they had as a matter of public record the objects and rules of the Society, and they could be referred to by anyone.

Rules of the Society.

The Honorary Secretary had circulated to all interested a copy of the syllabus which gave in an abbreviated form the rules and objects of the Society. These had been amplified to provide for every possible contingency, and in their full form were the Memorandum of Association. They had been approved by the Council and submitted to the solicitors with instructions to proceed with the incorporation of the Society.

Mr. W. G. Mitchell, B.Sc., F.R.Met.S., explained the aims of the Society for the benefit of new members, whom he had pleasure in welcoming. The aims of the Society, he said, were open for discussion. They seemed to him to fall under four heads:—

- (1) The study of television and its application in applied science and industry.

- (2) To afford a common meeting ground for professional and other workers interested in current research relating to television.
- (3) To encourage the formation and evolution of kindred societies in the provinces.
- (4) To afford facilities for the publication of recent research and matters of interest to members, and doing all such other lawful things as were incidental or relative to the attainment of the above objects.

Summary of Aims.

Summarised, these aims seemed to mean that they were all out to assist as a society in perfecting, as soon as it was possible, a system or systems of television.

They had to get down to practical details, and he wished it to be clearly understood that the Society did not aim at being a learned society in the sense that all its members held the very highest scientific qualifications. The Society aimed at being, if such an expression might be used, a body of amateurs keenly interested in television.

Television, it was generally agreed, was a possibility. It had been proved possible; but the great difficulty was to know what degree of perfection had been attained.

The general ignorance of the public on the difference between television and photo-telegraphy was surprising. In fact, so widespread was it that the publicity manager of one well-known wireless firm had found it necessary to address a circular letter to the technical press and the daily newspapers pointing out that there *was* a difference between television and photo-telegraphy.

The lack of knowledge on the subject was really astonishing. A day or so ago he was speaking to a friend who asked: "Does television mean that our homes will no longer be private, and that we shall be able to see what is happening anywhere?" The question illustrated the vague idea that seemed to be prevalent that television was something one just focussed on to any scene anywhere.

The Society could do much to clear up that misconception by means of popular lectures telling the average person exactly where we stood in the matter of television, and the exact state of progress in the science.

How was the Society to develop? That was a difficult point to discuss, for so much depended on the actual number of members and so much on local enthusiasm. It was to be hoped that there might be a parent society called the Television Society, with headquarters in London, and that in the provinces there would be a number of centres. These centres would, of course, be an integral part of the Society.

Probably the Society would develop along much the same lines as the Radio Society, but he very much hoped that there would be no antagonism between themselves and the Radio Society. Each had its own distinct work.

They needed a lead from some of the men in this country and abroad who had devoted themselves almost entirely to the study of television, in order to know, as it were, where they stood and where they could start from.

The study and development of television along amateur experimental lines seemed likely to be a rather expensive matter for an individual, but not for a society.

Television at present was in much the same position that wireless was

in 1912, when the Wireless Society of London was formed. The position of wireless in those days was that it had been proved possible. Results had been achieved, but their value had not been exploited or even fully appreciated.

A Lead Required.

Television at present depended for its success upon some form of light-sensitive cell, and a lead was wanted as to the best type of cell to use. Most of those present probably had had very little practical experience of the working of light-sensitive cells, and as these things were expensive such experience could probably best be got by people working together in a recognised centre such as the Television Society proposed to establish.

In the course of the discussion which followed Mr. Mitchell's speech Dr. Tierney pointed out that the need for lectures had been foreseen by the Council, and they would be arranged for. So would practical demonstrations, although these would largely depend on the members coming forward with the pieces of apparatus with which they had been working.

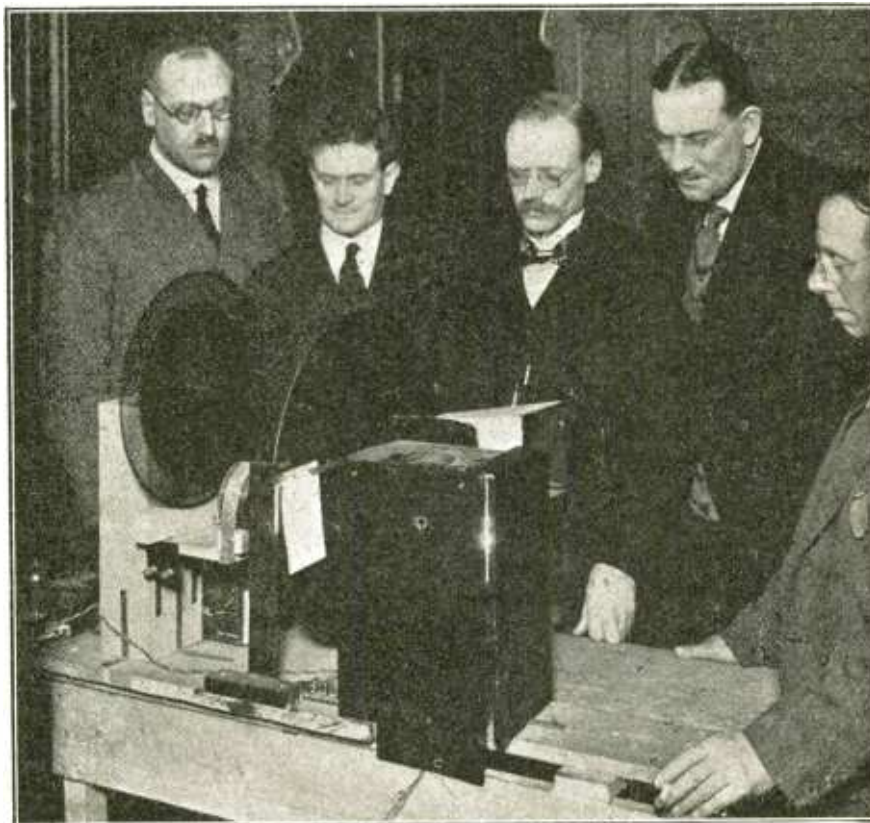

Members of the Council of the Society examining the Simple Televisor after the meeting. Left to right: Lt.-Col. YELF, Mr. Wm. C. KEAY, Dr. CLARENCE TIERNEY, D.Sc., F.R.M.S., Mr. W. G. MITCHELL, B.Sc., F.R.Met.S., Mr. J. J. DENTON, A.M.I.E.E.

Authoritative Lectures Required.

Mr. Mitchell had referred to the need for a lead from definite workers in television. That also had been thought of, but he would like to warn them that there were not many such workers; they were, in fact, very few, but as opportunity occurred they would be invited to give before the Society practical demonstrations of their methods and technique, and describe the results they had attained.

The idea underlying the formation of the Society was not that it should exploit any one system of method, but that it should be open for all to come forward and give their results.

A number of other points were referred to in the discussion on the formation and conduct of the Society. Among other speakers, Lt.-Col. J. R. Yelf said he saw that the Articles of Association provided that anyone over 21 years of age could be a member. That perhaps might be modified, particularly for provincial centres, so that junior members might be admitted, for there were many young men of 16 or 17 who were very keen indeed on the subject.

Replying to the discussion, Dr. Tierney said he would be sorry if the idea got about that provincial societies were being dominated by the London branch of the Television Society. At present there was merely the Television Society, a national society which had its headquarters in London, as was only natural. London would have its branch, as would any other town, and each would be equally a part of the Television Society, which would be everywhere.

An Invitation to Foreign Workers.

For example, if a well-known television worker from abroad came to this country and was staying, say, in Glasgow, he would be invited to lecture and demonstrate before the Society, and if he consented a meeting of the Society would be called which would be held in Glasgow, any members of the Society who cared to, travelling to Glasgow to attend the meeting.

The suggestion of Col. Yelf was a useful one. He was sure the junior members, as they might be called, were the ones who would most keenly assist in the development of television, and opportunity should be afforded them to meet present workers.



The Chairman, Mr. CLARENCE TIERNEY, watching the image on the screen of the Simple Televisor

The Value of Youth.

"Depend upon it," said Dr. Tierney, "a good deal is going to come from these young members. Luckily they know nothing of disappointment. That is where we old fogies go wrong. I can well foresee that the junior members are going to be an important element in the provincial centres."

He was sure the Secretary would make a note of that point, and when the very few brief rules were being drawn up for the guidance of provincial centres and local branches provision would be made for junior members.

Mr. A. Dinsdale, who gave a brief address on papers for publication, said that there was a demand for papers on all the various phases of television and on the several sciences which bordered upon television and tended to become linked up with it.

He pointed out, however, that those in possession of the necessary knowledge to write such papers would do well to bear in mind the fact, already referred to by Mr. Mitchell, that the vast majority of people, although perhaps keenly interested in television, knew nothing at all about the scientific side of it. He explained that as editor of the Society's official organ he had received hundreds of letters from readers who frankly confessed their total ignorance of scientific matters, including even wireless.

Under these circumstances he suggested that when papers were being prepared this very general ignorance of television and its allied subjects

should be borne in mind. Papers should be written as simply as possible, and where it was necessary to make use of technical terms the meaning of these should be carefully explained.

When broadcasting was first inaugurated there was a tremendous interest in the subject; but there was an equally great ignorance of the technicalities. The popular journals which sprang up then had to start at the beginning and explain every detail in the simplest possible language. Similarly, journals devoting themselves to television would have to follow, at any rate for some time, the same policy.

Mr. Baird to Address Next Meeting.

At the conclusion of the meeting Dr. Tierney announced that Mr. J. L. Baird had promised to address the next meeting of the Society, to be held at the Engineers' Club on May 1st. He was sure Mr. Baird needed no introduction to members of the Society, as his pioneer work in television was a matter for household discussion all over the civilised world. He considered that the Society would not fail to appreciate the high honour which Mr. Baird would confer upon it by his attendance on May 1st.

After the meeting a simple form of televisor for the transmission and reception of shadows was successfully demonstrated and explained by Mr. F. J. Bingley, B.Sc. The illustration at the head of this report shows members crowding round the instrument.

Natural Vision and Television.

Part I.—The Rudiments of Sight and Colour Vision.

By J. DARBYSHIRE MONTEATH.

ALL who would advance television should study the facts of natural vision, both objectively and subjectively, and consider the physical and chemical as well as the physiological and psychological nature of the eyes, with a view to understanding the underlying phenomena of the sense of sight and the visioning of colour. This should be undertaken with the object of seeking principles applicable to the production of the perfect televisor.

The Human Eye.

By reference to a simple diagram of the eye (Fig. 1) it will be seen that the rays of light from a scene or object, or light source, enter the eye where mechanism exists for controlling and protectively filtering the rays, and for focusing them as they reach the retina, in order to produce the image.

A Blind Spot in the Eye.

If the image should fall where the nerve trunk enters the retina nothing will be seen, as the nerve itself is not sensitive to light. It is the elements of the retina that register the presence of the image.

Referring to Fig. 2, hold the paper about a foot away, close the left eye, and very gradually bring the paper near to the open right eye, taking care to stare at the cross mark. When the large blot is near enough to be focused on the optic nerve it will disappear from sight.

Test this again by moving the paper a little nearer, and then a little further away, very slowly.

To plot on paper your own dark spot, fix the head restfully nearly a foot away from a sheet of white paper, then move a feather very carefully about in all directions. Whenever the tip of the feather appears make a small mark, and so plot a blind spot area accordingly.

It is well known that the optical system of the eye agrees with the

principles applied in practical physics, for the eye as an optical instrument is comparable to the photographic camera and the camera obscura, and obeys the optical laws so well described in television optics by Prof. Cheshire.

Problems of the Retina.

But as yet no physical concept has been apportioned for our sense of brightness or the faculty spoken of as "the gift of sight." Nor do we

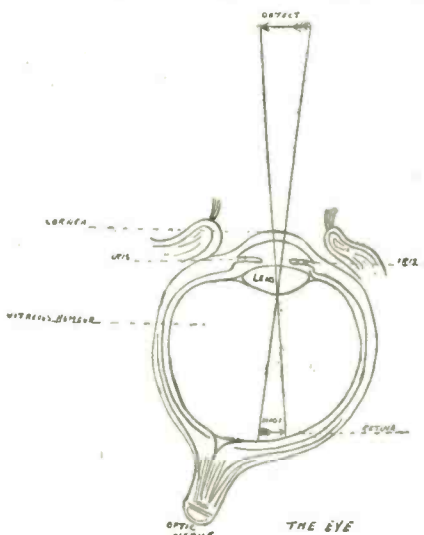

Fig. 1.
Diagram of the human eye, showing how an image of an object is focused on the retina.

understand the behaviour of that delicate transparent membrane which forms the image screen, and organ of vision, called the retina, whose function it is to televise the details of the image to the brain.

The microscope reveals that the retina is made up of a number of layers consisting of light-sensitive cells and fluids, mixed up with nerve filaments, leading to nerve cells and nerve fibres which extend to the brain. (See Fig. 3). Indeed the eye, as far as the retina is concerned, may be considered as an outgrowth of the brain.

Light having passed the lens system of the eye, falls on the layer of nerve fibres, which varies in thickness at different parts of the retina, and consists of filaments that radiate from the half million nerve fibres that make up the optic nerve trunk, which latter continues to the brain.

Where Sight Begins.

But visual impulses do not appear to begin until the light has penetrated most of the retinal layers and reached the two types of cells known as the rods and cones, and when any of these are destroyed corresponding dark spots appear in the field of vision.

A Natural Vision Shadowgraph.

The evidence that sight begins at the rods and cones provides us with another experiment.

Let your eye look steadily into the darkness (in a dark room) while a small light is moved to and fro close to the eye, and you will see dark branching lines on a dull red ground.

This is a shadowgraph of the retinal blood vessels, projected on the sensitive layer of the retina, and it is the dilation of these blood vessels occurring at the height of a temper that makes us "see red." As these blood vessels are in the inner layers of the retina the shadows sensed must be further through the layers; so that it seems clear that visual impressions evidence themselves at a position where the rods and cones exist, and that these latter function with the nerve filaments that reach the optic nerve.

The Rods and Cones.

It is found that the inner limbs of the cones under the action of light become shorter, and elongate in the darkness. The action is the same in both eyes, although only one eye is

allowed to receive the light. If the brain is destroyed only the cone in one eye is affected, and that is where the light is present. Investigations are being made by physicists to decide the photo-electrical properties of the rods and cones.

It is still impossible to say which are the more important, as rods are absent from the eyes of some seeing animals, and the cones are absent from others.

Visual Purple.

The outer limbs of the rods are tinged with a fluid pigment known as visual purple, and light may effect chemical changes here which are important to vision. Yet some animals see that have no visual purple in their eyes.

At the part of the retina which receives the image are the pigment cells, which consist mostly of tiny six-sided cells containing pigment. (See Fig. 4). They are all in a single layer and from them beard-like fringes extend to the outer ends of the rods, which themselves contain the reddish visual purple. This pigment (rhodopsin) may be extracted from eyes that have been kept in a 10 per cent. solution of salt by means of a 2½ per cent. solution of bile-acids.

Visual purple is not acted upon by oxidising agents, but zinc chloride,

acetic acid, or corrosive sublimate will turn it yellow. Only light will turn it white. Red light has no action on it; greenish-yellow light produces the maximum bleaching effect.

If an animal is killed whilst looking



Fig. 2.

Look for the blind spot in your own eye, as explained in the text. (Marriott's Experiment, 1688.)

at a bright object, particularly if the eye of the animal is in comparative darkness, the image of the luminous object will be bleached on the retina, the neighbouring portion of the retina remaining purple. In fact an optigram or optigraph of the object may be "fixed" on the dead retina by aid of a 4 per cent. solution of alum.

The Sensation of Colour.

The human eye sees light over a strictly limited range of the spectrum, but a sense of pain indicates the presence of invisible rays when they are intense, although normally these are mostly absorbed by the aqueous humours of the eye.

wave-length or characteristic sensation.

For instance, yellow will be seen when green and red light are mixed in the right proportions. Blue and yellow light together will produce a white light sensation, and for this reason they are called complementary colours.

White light may be produced from any of the following pairs of coloured lights.

- Red and greenish blue.
- Yellow and indigo blue.
- Orange and cyan blue.
- Greenish yellow and violet.

Yet blue and yellow pigments when mixed and viewed in white light produce the sensation of green, because the pigment absorbs certain wave-lengths of light from the incident beam.

Lantern Experiment.

Let the light from an arc lantern pass through a blue solution, and catch the beam on a sheet of cardboard which has been painted yellow. The card will appear green, because the yellow will absorb the blue light and reflect the green that has passed through the blue solution.

The same effect is obtained if a yellow solution is used and a blue card is substituted.

Selective Absorption.

The white light that falls on a coloured body has all its colour components absorbed except the particular colour which it reflects.

Project on a screen the light from a red glass slide, and the screen will be red, for the coloured slide has selectively absorbed all constituents of the luminous beam except red.

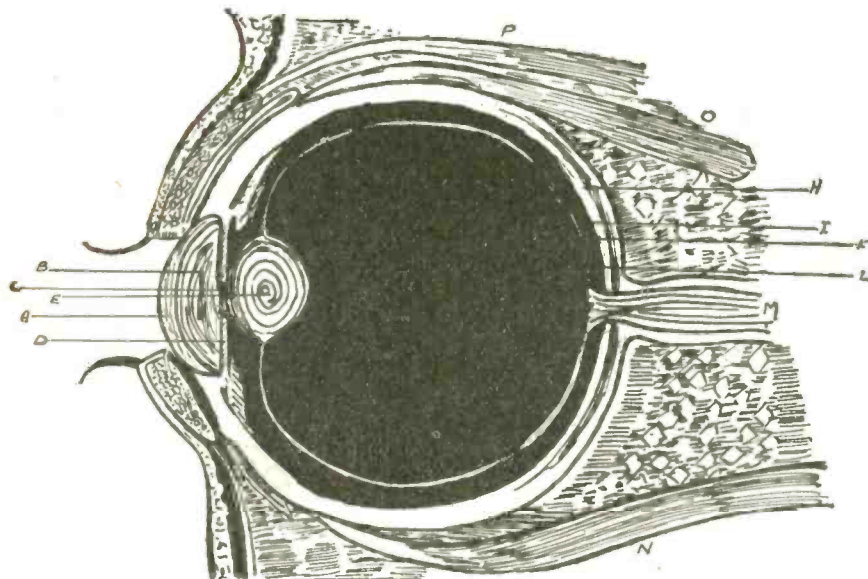

REPRESENTATION OF A VERTICAL CUT THROUGH THE EYEBALL IN ITS SOCKET.

P, N, muscles of eyeball; A, cornea, which closes the front of the anterior chamber, B, which is filled with aqueous humour, and the back wall of which is formed by the curtain of the iris, D. In the middle of the back wall is the opening of the pupil C, through which is seen the lens E. Behind the lens is the posterior chamber L, filled with vitreous humour. Entering the eye from behind is the optic nerve M, which is distributed to the retina K. The posterior wall of the eye shows from within outwards the image-forming retina, the dark choroid with blood vessels I, and the firm protective sclerotic H.

The same effect is produced by a blue glass slide. If, however, the red and the blue slide be together projected the screen will be black, for the beam has been subjected to a process of double absorption.

Produce a spectrum, and place a piece of red cloth in the part that is red, and the cloth will reflect red light; place it in the green or the blue bands and it appears to be black; so that colours reflected from opaque bodies depend on the rays the body can reflect.

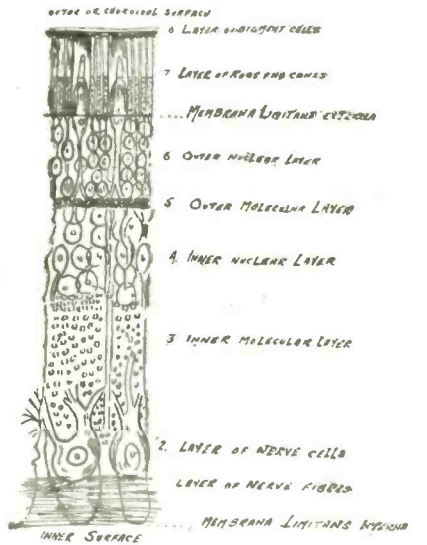

DIAGRAMMATIC SECTION OF THE HUMAN RETINA

Fig. 3.

There is a large field for research in connection with sight and colour, and facts like the following have interest for the television experimenter.

A shorter time is required to perceive yellow light than for red and purple light.

Blue light at its feeblest brightness to produce a colour sensation requires sixteen times less intensity of brilliance than that required to produce a comparable sensation for red light.

A dark object always appears smaller when placed against a bright one.

After-Images.

Look at the red setting sun for a moment or so, then turn the eyes to a white ceiling, and realise first the persistence of the red image (positive after-image) and alternately the change to a green image (negative after-image). Or observe a red ink blot on a sheet of white paper, which

will change to a green "after-image" as you stare at a blank space on the paper. And generally in the case of eye fatigue all colours will appear except the one that has caused the fatigue.

Persistence of Vision.

Persistence of vision is all-important for the practice of television, and this property of "the lag of the retina" has long been recognised.

In 1550 Cardanus described the Zoetrope, and more recently Plateau's Phanakistoscope and Stamfer's Stroboscopic disc have been utilised to demonstrate the phenomenon. By means of such apparatus it can be very clearly shown that the impression of one image remains till the next image takes its place.

In fact to-day we exploit the principles of these instruments in the cinematograph and the televisior.

Electric Shock and Persistence of Vision.

From first-hand knowledge we are able to describe an occasion when a full-sized natural image of the left hand persisted so long that the right hand had time to seek and hold the left hand, which had been moved behind the back, immediately following an intense electric shock.

An excited description of the impression during its duration evoked from a friend the inquiry: "Would it advance television if the demonstrations were made under those conditions for all present?"

In Part II we shall discuss "The Yellow Spot": A theory of colour vision and the prospects of colour television.

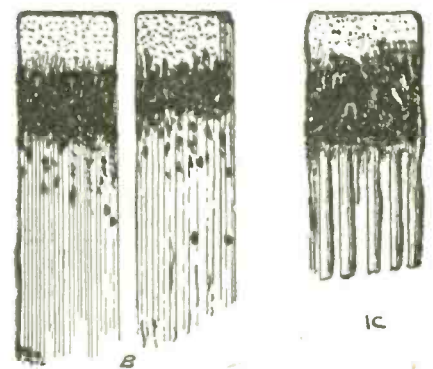

PIGMENT CELLS OF THE HUMAN RETINA

Fig. 4.

A, cells seen from the outer surface with clear lines of inter-cellular substance between. B, two cells seen in profile with fine offsets extending inwards. C, a cell still in connection with the outer ends of the rods.

LISENIN

POSITIVE GRIP TERMINALS ARE ABSOLUTELY IDEAL.
(Patent No. 245586.)

Wander Plug
Note taper.
2d.

Spade End.
4d.

Plug and
Socket, 4 1/2d.

Socket and
Plug, 4 1/2d.

"RADIO FOR THE MILLION"
"AMATEUR WIRELESS"
"WIRELESS WORLD" SETS
AND BY LEADING SET MANUFACTURERS.
Follow the Lead of Experts. Insulated sleeves are made in standard colours, Red, Green, and Black. Plugs and sockets are interchangeable, and all metal parts N.-plated. Liberal discounts to Manufacturers; samples gladly submitted to Trade enquirers.

THE
LISENIN WIRELESS Co.,
17, Edgware Rd., London, W.2
Phone - Paddington 2734.

5 Catalogues FREE

THERE ARE OVER 250 "gadgets" and components shown in our catalogues. Many of these are suitable for use in Television apparatus and you cannot afford to be without them. Write for your copies to-day.

A.F. BULGIN & CO
9, 10, 11 CURSOR ST. CHANCERY LANE, E.C.4
TRADE DECKO MARK



THE BEST LETTERS OF THE MONTH

TELEVISION IN MID-ATLANTIC.

R.M.S. Berengaria,
SOUTHAMPTON.

April 4th, 1928.

To TELEVISION PRESS, LTD.,
26, CHARING CROSS ROAD, S.W.

DEAR SIR,

Having seen a statement in the Press to the effect that everyone present at the demonstration of television on the R.M.S. Berengaria on March 7th was connected in some way with the Baird Company, I wish it to be known in the interests of the science of television generally that I had the pleasure of being present every night while the experiments were in progress.

On looking at the screen of the television, I saw rapidly moving dots and lines of orange light which gradually formed themselves into a definitely recognisable face. This image varied from time to time in clarity, but movements could be clearly seen, and the image when clear was unmistakable.

In conclusion it is perhaps unnecessary for me to mention I have no connection whatsoever with the Baird Company.

Yours faithfully,
W. SUTCLIFFE,
Staff Chief Engineer,
R.M.S. Berengaria.

25, HADDENHAM ROAD,
LEICESTER.
April 13th, 1928.

THE TELEVISION PRESS, LTD.,
26 CHARING CROSS ROAD,
LONDON, W.C.2.

DEAR SIR,

Please find enclosed forms duly signed and filled in and should be glad of your constructor's sub-licence.

I am an experimenter and am greatly fascinated by your "How to Make a Simple Telesvisor"; also think it impossible for anybody not to understand your open, plainly written article, and hope to be able to write later of the results I have made with this instrument.

With the best of luck to the first monthly television journal. With hopes for a weekly one from you.

Yours faithfully,
W. DAY.

THE LICENCE QUESTION.

35, FARMER STREET,
HEATON NORRIS,
STOCKPORT.

April 10th, 1928.

To the Editor of TELEVISION.

SIR,

The public-spirited act of the Baird Television Development Co. in granting constructor's sub-licences is a great concession to the amateur scientist. The old saying, "Never look a gift horse in the mouth," is apparently without significance for your correspondent Mr. P. L. Holdsworth. However, the definite and complete reply of the Baird Co. to his ridiculous letter is a pleasing feature of the current number of TELEVISION. As an old "wireless" experimenter, I salute Mr. Baird, who has provided us with yet another and larger field for experiment. I enclose form for constructor's sub-licence duly filled in. With every wish for the prosperity of TELEVISION.

Yours faithfully,
DOUGLAS C. ROWLAND.

16, DINGWALL AVENUE,
E. CROYDON, SURREY.
April 5th, 1928.

To MESSRS. TELEVISION PRESS, LTD.,
26, CHARING CROSS ROAD, W.C.2.

SIR,

I beg to acknowledge the receipt of the Constructor's Licence No. 547, for which I thank you.

I should like to congratulate you upon the excellent manner in which you present the latest science in clear and comprehensive language, and your journal should meet with all the success it deserves.

Yours truly,
H. J. HOLFORD,
Civil Engineer.

8, CAXTON ROAD,
SHEPHERD'S BUSH,
LONDON, W.12.

To the Editor of TELEVISION.

DEAR SIR,

I trust I shall not occupy unnecessarily your time by perusal of this letter, but I was much interested in your publication

of the statements of Mr. P. L. Holdsworth and the Baird Television Development Co., Ltd.

In supposing the conception of B.T.D. Co., Ltd., right, this would mean that an inventor of any unpatented article would be liable to prosecution for using his own invention by a copyist or even simultaneous inventor who happened to patent the article.

Consequently components already in use but not patented would become infringements if they were later reinvented (a quite possible supposition) by anyone who patented them.

Surely this is unfair to everyone who cannot afford to patent any creation they may make.

With every respect and gratification to TELEVISION,

I am, yours sincerely,
ARTHUR E. J. BUTT.

[It is well known that in some instances apparatus has been invented by two persons practically simultaneously, but the person who applies for protection in respect of his inventions gains priority over the other person who may have invented similar apparatus at the same time, and the usual patentee's rights would govern the use by his rival of the apparatus. We heard of a case recently where an inventor got to the Patent Office just twelve hours ahead of a simultaneous (and independent) inventor of the same device.—EDITOR.]

2, CENTRAL DRIVE,
SHIREBROOK, MANSFIELD.
April 14th, 1928.

To the Editor of TELEVISION.

DEAR SIR,

Please find enclosed application form for a constructor's sub-licence.

In spite of its short life TELEVISION promises to give a clear insight into this almost miraculous science, which, like your paper, is only in its infancy, but which has such glorious possibility for the near future.

I, being only eighteen, am probably one of your youngest applicants for the licence.

Wishing your paper every success.

I remain, yours sincerely,
J. VARDIF ROBERTS.

Jock McKay

(concluded from page 32).

advance in civilisation, Jeanie. Rot-ten eggs would become a thing o' the past."

"But surely they're that already, Jock."

I ignored her cheap wit and pro-ceeded from ma book as follows, viz. :—

"A careful study o' the cow is also gey important. For example, if a farmer finds he's no' getting satisfactory quantities o' milk frae a cow he's got to decide if it's because that kind o' cow's nae guid for milk, or because that particular cow's just constitutionally a lazy cow and lies about twiddling her thumbs when she should be chewing the cud. It would be a bittie hasty, ye see, Jeanie, if he was to say right off that breed o' cow was nae guid. It would be jist like me saying 'wumman as a whole was ignorant bodies,' jist frae ma experience

o' . . . Ay, ye see what I mean, onyway.

"A careful study o' the Cow."

"Weel, television'll change all that. Jist picture the farmer watching his screen whiles he's shaving himsel about 3.39 a.m. approx. 'Ye're chewing fine, Jessie,' says he. Jessie's the cow ye ken. Then: 'Ma con-science, what's that?' And there afore his eyes is the solution o' the mystery, Jeanie. Nae small wonder Jessie canna dae hersel justice when it comes to milking-time. Ye see, that was Alec Andrews, the village idiot, which was milking Jessie un-officially in advance. Is that no' marvellous?"

"How muckle are ye going to make out o' yer idea, Jock?"

And if that's no' jist like a wumman.

"Madam," says I, lofty, "vision-aries are unpaid, unhonoured, and unsung." And wi' these words I departed for "The Auld Black Crow."

All Communications
respecting

ADVERTISEMENTS

should be addressed to:—

"TELEVISION"

Advertisement Dept.,
Kingsway Corner Buildings,
109, Kingsway, W.C.2.

Telephone: HOLBORN 7070

TELEVISION PARTS

ELECTRIC MOTORS from 12/6; NEON LAMPS, 2/6; SELENIUM CELLS, 10/-; PROJECTORS, £1 5s.; 500 CYCLE ALTERNATORS AS DESCRIBED IN THIS ISSUE £3 10s.



200 WATT MIDGET ALTERNATORS.

The most perfectly made A. C. Generator. Gives 500 cycle 20 volts 10 amps, weight 7½ lbs., in aluminium cover. The Generator of unlimited possibilities. The

machines are fully guaranteed. With transformer, any H.T. voltage from 500 up to 3,000 volts may be obtained, smoothed and rectified for H.T. The wonderful little machines cost £30, and are given away at 70/- each. Technical Depts. and Colleges all over the world use these, and stock cannot be replaced. Sale Price, £3 10s. cash with order.



THE DIX-ONEMETER. The 55 Range

"Rolls Royce" of Radio. An instrument of exact precision reading, 40 micro-amp. to 20 amps., 2 milli-volts to 2,000 volts. Measures Crystal Signals or Resistances from 50 ohms to 50 megohms. Instrument de Luxe, 55/- Multipliers, each, 6/6. Projector Bulbs, 9/-; Focusing Arc Lamps, £3; 2½" Brass Tubes with lenses, 17/6; 1,000 volt Generators, £5 10s.; 3-Valve Amplifiers, £2 10s; Osram Power Valves, 7/6.

Send us your enquiries for Dynamos and Alternators, Recorders, Relays and Special Apparatus. Now Ready, New Edition of 72 page Illustrated Catalogue, 4d.

ELECTRADIX RADIOS.

218, UPPER THAMES STREET, LONDON, E.C.4.

INDEX TO ADVERTISERS.

	PAGE
Bulgin, A. F.	42
Celestion Radio Co.	25
Chloride Electrical Storage Co., Ltd.	31
Colvern Ltd.	1
Dubilier Ltd.	iv
Economic Electric, Ltd.	2
Electradix Radios	44
Hart Accumulator Co., Ltd.	2
Igranic Electric Co., Ltd.	iii
Jackson Bros.	2
J.R. Wireless Co.	2
Langham Radio	14
Lisenin Wireless Co.	42
Lissen Ltd.	13
Melhuish C. D., Ltd.	2
Mullard Wireless Science Co., Ltd.	ii
Philips Lamps Ltd.	6
R. I. Varley, Ltd.	5
Television Supplies Ltd.	3
Wet H.T. Battery Co., Ltd.	1

Mention of "Television" when replying to advertisements will ensure prompt attention.

Start with a good foundation

Start your experiments in television with these Igranic amplifier components. You will then know that, whatever the first results, your amplifier components are above suspicion. Igranic components are designed in one of the best known radio research laboratories in England by engineers who are specialists in their line. They are manufactured in a modern works equipped with every facility for precision production and they are made from the best materials obtainable. Such are the exhaustive tests given to each component before it leaves the works that Igranic guarantee to replace it if it does not prove satisfactory. You therefore take no risks.

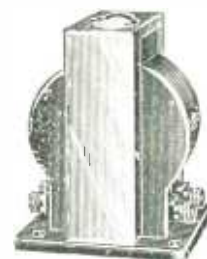

L.F. Transformer, Type "G."
gives the most even amplification of all frequencies under working conditions. A massive instrument in which neither materials nor workmanship has been stinted. Two ratios, 30:1 for 20,000-30,000 ohm valves and 7:2:1 for 5,000 ohm valves.

Price 30 -



Igranic Wire-Wound Shielded Resistor.

The perfect wire-wound resistor for R.C. coupling. Being shielded, stray capacities are eliminated and a straighter characteristic is obtained at the high frequencies.

50,000 ohms	Price 4 6
150,000	5 6
250,000	7 6

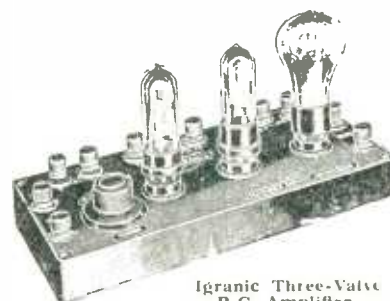

Igranic Three-Valve R.C. Amplifier.

Three stages of perfectly designed resistance capacity amplification. Amplification control is provided. The most even amplification possible is obtainable with this amplifier.

Price 50 -,
without valves and royalty.



Igranic L.F. Choke, Type "G."

The best low frequency choke made. Exceptionally high maximum inductance of 370 henries. By connecting the two sets of terminals in parallel an inductance of 80 henries is obtained. A really massive job.

Price 27, -



Igranic Filament Rheostats.

This is one of a range of rheostats which meet every possible requirement for perfect voltage control.

Prices from 2 to 4, .



Igranic Universal High Resistance.

The only satisfactory type of amplification control for transformer or R.C. amplifiers. Potentiometer type.

Model A—0-1 megohms.
Model B—0-5 megohms.
Price 5/6 as illustrated.



Igranic-Pacent Pre-Set Resistor.

For the base-board control of valve filaments. Ideal where a panel rheostat is not required.

Price 1/8.

The complete illustrated Igranic Catalogue, List No. J547, gives full particulars of the full range of Igranic Components



149, Queen Victoria Street, London, E.C.4

Works: BEDFORD

Branches:

MANCHESTER, BIRMINGHAM, CARDIFF, LEEDS, NEWCASTLE, BRISTOL, GLASGOW

Mention of "Television" when replying to advertisements will ensure prompt attention.

ON ALL POINTS



2

Mr. Baird uses Dubilier Components in his Television experiments because he knows the need there is to use only efficient components when building a set—that however good your circuit, you must have reliable components to obtain the best results. And especially does this apply to experimental work: for unless you can depend on the parts to function properly, neither can you on the results you get.

"Dubilier Built is Better Built."

Write for our 1928 Catalogue showing full range of Dubilier products.

(1) Dubilier Mica Condenser.—Type B775. Made in 14 standard capacities between 0.02 mfd. and 0.3 mfd. Prices from 5/6 to 22/6.

(2) Dubilier Mansbridge Condenser.—Type BB. 0.5 mfd.. 2/6; 1.0 mfd.. 2/6; 2.0 mfd.. 3/6.

(3) Dubilier "Duwirohm" Resistance.—10,000 to 100,000 ohms, 5/- each; 150,000 and 200,000 ohms, 8/- each; 250,000 ohms, 9/9 each; 300,000 ohms, 11/6 each "Duwirohm" Holders, 1/6 each.

(4) Dubilier "Dumetohm".—0.25 to 10 megohms. 2/6 each. "Dumetohm" Holders. 1/- each.

If unobtainable from your dealer send direct to us.

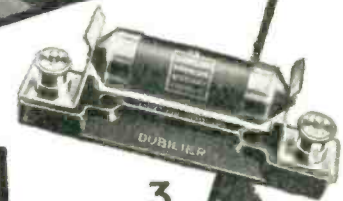

3



4



THE "STARS" IN EVERY GOOD CIRCUIT

Adv. of the Dubilier Condenser Co. (1925), Ltd., Ducon Works, Victoria Road, North Acton, W.3.

©138

Printed by HAZELL, WATSON & VINEY, LD., 52, Long Acre, London, W.C. 2, and published for the Proprietors, TELEVISION PRESS, LTD., 26, Charing Cross Road, London, W.C. 2, by THE ALDINE PUBLISHING CO., LTD., Crowl Court, Clancery Lane, London, W.C. Address for advertisements, "TELEVISION" ADVERTISEMENT DEPT., 65, Lincoln's Inn Fields, London, W.C. 2. Sole Agent for U.S.A., INTERNATIONAL NEWS. Registered for transmission by Canadian Magazine Post.